

BMDFM

Comprehensive Manual

2018

Oleksandr Pochayevets

This page is intentionally left blank.
Contents of the document begins on the next page.

Table of Contents

About This Manual and License Terms	vii
Chapter 1	
Introduction	1
Chapter 2	
Architectural Overview	5
2.1 Static Scheduler	6
2.2 Dynamic Scheduler.....	7
2.3 Configuration.....	8
2.4 Top Screen of the Running System	13
Chapter 3	
Installation and Use	15
3.1 Structure of Modules on the Disk.....	15
3.2 Programming and Compilation.....	17
3.3 Singlethreaded Engine	20
3.4 Server Unit.....	22
3.5 External Task Unit.....	25
3.6 External Tracer Unit	27
Appendix A	
Programming Language Reference	29
A.1 Program.....	29
A.2 Constant definition.....	30
A.3 Variables	31
A.4 Special construction functions	33
A.5 Input/Output functions	35
A.6 Built-in comparison functions	37
A.7 Built-in boolean functions	38
A.8 Built-in integer functions	39
A.9 Built-in float functions.....	42
A.10 Built-in string functions	45

Table of Contents (cont.)

A.11 Built-in asynchronous memory heap functions	50
A.12 Built-in mapcar function	52
A.13 Built-in terminal capabilities functions.....	53
A.14 Built-in constant and info functions.....	55
A.15 Built-in rise runtime error functions	58
A.16 C Interface.....	59
Appendix B	
Example of Application Programming.....	69
Appendix C	
List of Target Deployments.....	81

List of Figures

Figure 1-1. Running BMDFM on different machines	3
Figure 2-1. BMDFM architecture.....	5
Figure 2-2. Architecture of static scheduler	6
Figure 2-3. Architecture of dynamic scheduler	7
Figure 2-4. Configuration example for a 1024-way SMP machine.....	12
Figure 2-5. BMDFM running on a 4-way SMP machine	13
Figure 3-1. BMDFM modules	15
Figure 3-2. BMDFM directory tree	16
Figure 3-3. BMDFM user application life cycle	17
Figure 3-4. BMDFM user application structure	18
Figure 3-5. Recompile of the BMDFM modules	19
Figure 3-6. BMDFM singlethreaded engine command line syntax	20
Figure 3-7. BMDFM singlethreaded engine work flow	21
Figure 3-8. BMDFM Server command line syntax	22
Figure 3-9. BMDFM Server unit work flow	23
Figure 3-10. BMDFM Server console view	24
Figure 3-11. External task unit command line syntax	25
Figure 3-12. External task unit work flow.....	26
Figure 3-13. External tracer unit command line syntax	27
Figure 3-14. External tracer unit work flow	27
Figure 3-15. External tracer console view.....	28
Figure B-1. Computation example of discrete Hartley transforms.....	69

List of Figures (cont.)

About This Manual and License Terms

This manual gives an overview of the BMDFM software. The BMDFM architecture, installation procedure and programming language are described.



Use of the BMDFM software is subject to license restrictions. Carefully read End User License Agreement (EULA) before using this software.

If you do not agree to the terms and conditions specified in the EULA, please destroy all your copies of the BMDFM software from any drives, disks, tapes or other storage media and recycle all related printouts immediately.

End User License Agreement (EULA)

1. The BMDFM Software is distributed to an end user ("End User") as a binary code at no charge.
2. End User accepts a non-exclusive, non-transferable, royalty-free use of the BMDFM Software for non-commercial purposes. Any commercial use requires a separate license. End User may build own applications and create derivative works based on the BMDFM Software. End User has specific rights to create additional copies of the BMDFM Software as necessary for archival purposes and to modify the BMDFM Software as necessary to allow it to operate on the End User's equipment. End User may not reproduce and distribute the BMDFM Software.

3. End User agrees to respect and not to remove, obliterate, or cancel from view any copyright, trademark, confidentiality or other proprietary notice, mark, or legend appearing on the BMDFM Software or output generated by the BMDFM Software, and to reproduce and include same on each copy of the BMDFM Software.
4. End User agrees not to disassemble, decompile or reverse engineer the BMDFM Software, or any portion thereof.
5. End User further acknowledges that all copies of the BMDFM Software in any provided form are the sole property of the BMDFM official suppliers. End User shall not have any right, title, or interest to any such BMDFM Software or copies thereof except as provided in this EULA, and further shall secure and protect all BMDFM Software and documentation consistent with maintenance of the BMDFM proprietary rights therein.
6. The BMDFM Software is provided AS IS. End User agrees that the BMDFM official suppliers shall not be liable for any costs, damages, fees, or other liability, nor for any direct, indirect, special, incidental, or consequential damages with respect to any claim by End User or any third party on account of or arising from this EULA or use of (or inability to use) any portion of the BMDFM Software.
7. **THE EXPRESS WARRANTY STATED IMMEDIATELY ABOVE IS GIVEN IN LIEU OF ALL OTHER WARRANTIES, EITHER EXPRESS OR IMPLIED, INCLUDING BUT NOT LIMITED TO THE IMPLIED WARRANTIES OF MERCHANTABILITY AND FITNESS FOR A PARTICULAR PURPOSE.**

Chapter 1

Introduction

What is BMDFM?

BMDFM (Binary Modular DataFlow Machine) is software, which enables running an application in parallel on shared memory symmetric multiprocessors (SMP) using the multiple processor cores to speed up the execution of single applications.

BMDFM automatically identifies and exploits parallelism due to the static and mainly DYNAMIC SCHEDULING of the data flow instruction sequences derived from the formerly sequential program ensuring unique parallel correctness.

No directives for parallel execution are required!

No highly knowledgeable parallel programmers are required!

What does BMDFM provide to a user?

A user understands BMDFM as a virtual machine, which runs every statement of an application program in parallel having all parallelization and synchronization mechanisms fully transparent. The statements of an application program are normal operators, which any singlethreaded program might consist of - they are variable assignments, conditional executions, loops, function calls, etc. BMDFM has a rich set of standard operators/functions, which can be extended by user functions written in C/C++.

In comparison with the recent general methodology of sequential code parallelization, which is based on static analysis, BMDFM uses dynamic scheduling to define and to run code fragments in parallel. It means that data computed at run time will define further branches for parallel processing

(DataFlow principle). It also means that loops of an application program will be dynamically unrolled to process several iterations in parallel.

Which granularity of parallelism is used in BMDFM?

BMDFM exploits fine-grain parallelism. All instructions of an application will be processed in parallel. In addition, it is possible to exploit coarse-grain parallelism that will decrease costs spent on dynamic scheduling. In order to achieve this a portion of C code can be defined as a user function, which will be treated by the dynamic scheduler as one seamless instruction.

Which platforms may run BMDFM?

Every machine supporting ANSI C and POSIX/SVR4-IPC may run BMDFM.

Obviously, BMDFM is able to accelerate the execution time of an application only when installed on a multiprocessor computer implementing an SMP paradigm (hardware mapping of distributed memory into virtual shared memory, cache coherent non-uniform memory access ccNUMA, UMA!, etc.)

BMDFM is provided as compiled multi-threaded versions for:

- **x86:** **Linux/32, FreeBSD/32, OpenBSD/32, NetBSD/32, MacOS/32, SunOS/32, UnixWare/32, Minix/32, Android/32, Win-Cygwin/32, Win-UWIN/32, Win-SFU-SUA/32;**
- **x86-64:** **Linux/64, FreeBSD/64, OpenBSD/64, NetBSD/64, MacOS/64, SunOS/64, Android/64, Win-Cygwin/64;**
- **VAX:** **Ultrix/32;**
- **Alpha:** **Tru64OSF1/64, Linux/64, FreeBSD/64;**
- **IA-64:** **HP-UX/32, HP-UX/64, Linux/64, FreeBSD/64;**
- **XeonPhiMIC:** **Linux/64;**
- **MCST-Elbrus:** **Linux/32, Linux/64;**
- **PA-RISC:** **HP-UX/32, HP-UX/64, Linux/32;**
- **SPARC:** **SunOS/32, SunOS/64, Linux/32, Linux/64, FreeBSD/64;**
- **MIPS:** **IRIX/32, IRIX/64, Linux/32, Linux/64;**
- **MIPSEL:** **Linux/32, Linux/64, Android/32, Android/64;**
- **PowerPC:** **AIX/32, AIX/64, MacOS/32, MacOS/64, Linux/32, Linux/64, FreeBSD/32, FreeBSD/64;**

Introduction

- PowerPCle: **Linux/32, Linux/64;**
- S/390: **Linux/32, Linux/64;**
- M68000: **Linux/32;**
- ARM: **Linux/32, Linux/64, Android/32, Android/64;**
- ARMbe: **Linux/64;**
- RISC-V: **Linux/64;**

and¹ a limited single-threaded version for:

- x86: **Win/32.**

A machine with one CPU can be used for development and test purposes only as it is not possible to get real acceleration on one CPU. But as soon the application program has reached a certain state of maturity it can be moved to BMDFM running on a wide range of multicore/many-core computers (from tiny embedded devices to multiprocessor big iron mainframes) as shown in [Figure 1-1](#).

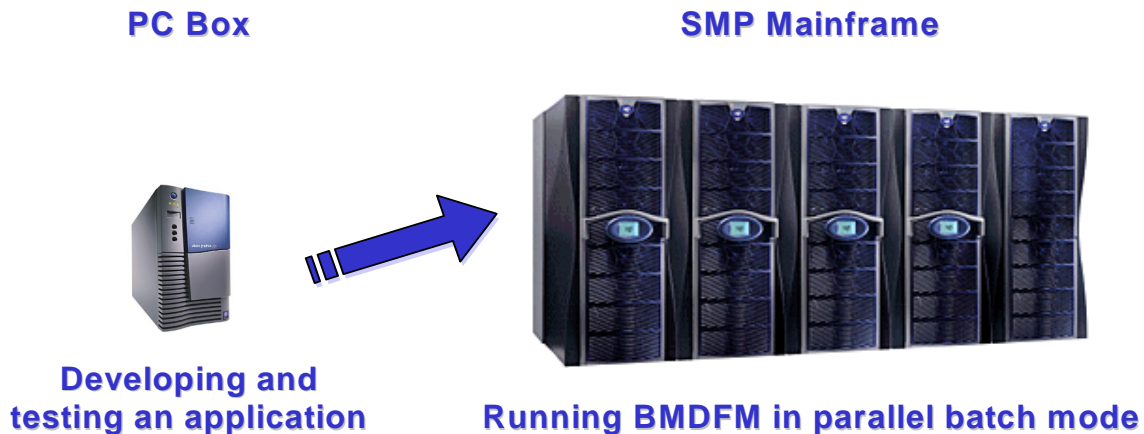

Figure 1-1. Running BMDFM on different machines



BMDFM Official Web Site: <http://bmdfm.com>

BMDFM Support: email to: bmdfm@bmdfm.de

1. Actual BMDFM installation factory package can provide additional compiled platform-specific versions.

This page is intentionally left blank.

Chapter 2

Architectural Overview

BMDFM uses both highly efficient dynamic and static scheduling combining SMP (Shared Memory Symmetric Multi Processing), MIMD (Multiple Instruction Stream, Multiple Data Stream) and DFM (DataFlow Machine) paradigms. The BMDFM architecture is shown in [Figure 2-1](#).

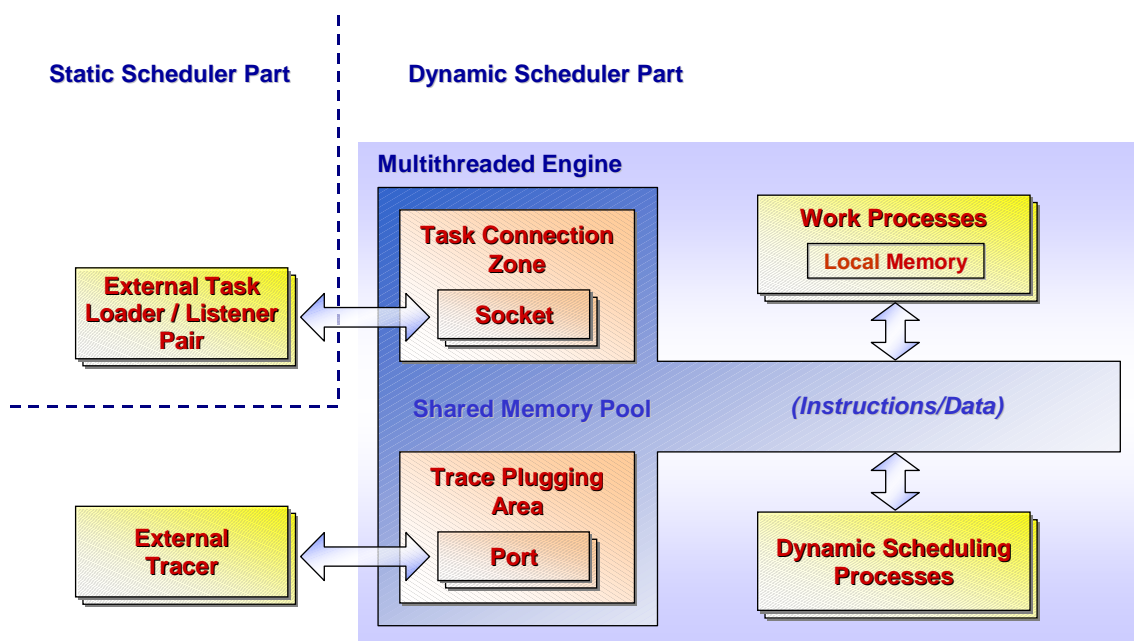

Figure 2-1. BMDFM architecture

A pool of processes is divided into two subsets: Work Processes, which execute parallel instruction streams, and Dynamic Scheduling Processes, which automatically convert sequential instruction streams into parallel ones.

Running under an SMP OS the processes will occupy all available real machine processors.

All processes share the Shared Memory Pool containing Instructions and Data. Each Work Process also has its own Local Memory, which may contain user subroutines to implement additional coarse-grain levels of parallelization. The External Loader/Listener Pair performs preprocessing and static scheduling of the input program instructions and stores them clustered in the Task Connection Zone. The Listener is responsible for the ordered output after the out-of-order processing in the Multithreaded Engine. Clustered instructions and data are fetched by the Dynamic Scheduling Processes into the Shared Memory Pool. Additionally, Dynamic Scheduling Processes release (garbage collect) resources after the data contexts and speculative branches are processed. Lastly, the External Tracers assist in debugging of the multithreaded out-of-order processing of the input program. The External Tracers are connected via the Ports of the Trace Plugging Area. The Tracer can operate in various modes of full/partial and master/slave debugging.

2.1 Static Scheduler

Figure 2-2 shows the static scheduling part of BMDFM. An application program (Input Sequential Program) is processed in three stages: preliminary code reorganization (Code Reorganizer), static scheduling of the statements (Static Scheduler) and compiling/loading (Compiler). The output after the static scheduling stages is a **Multiple Clusters Flow** that feeds the Multithreaded Engine via the Interface designed in a way to avoid bottlenecks. For some special cases, such as development of loaders, the Interface can be published. Multiple Clusters Flow can be understood as a compiled input program split on the marshaled clusters, in which all addresses are resolved and extended with context information. Splitting on the marshaled clusters enables loading them multi-threadedly. Context information lets iterations be processed in parallel.

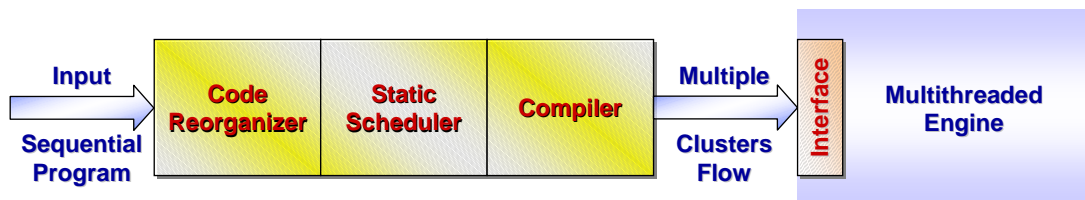

Figure 2-2. Architecture of static scheduler

2.2 Dynamic Scheduler

Figure 2-3 shows the part of BMDFM responsible for the dynamic scheduling in more detail. The BMDFM dynamic scheduling subsystem performs an efficient SMP emulation of the **Tagged-Token Dataflow Machine** as described below.

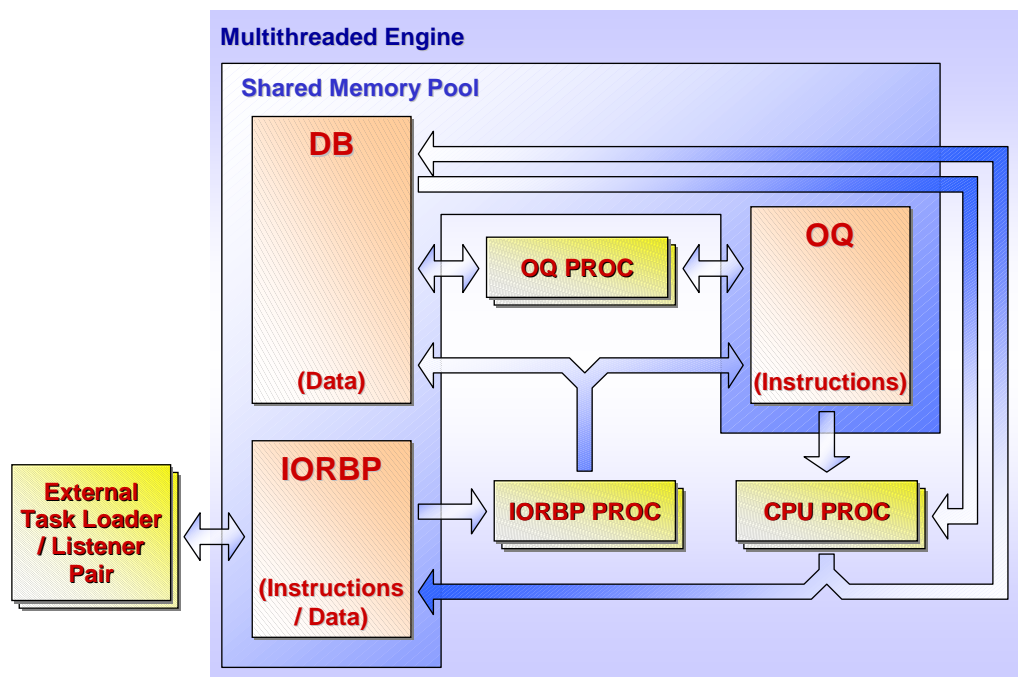

Figure 2-3. Architecture of dynamic scheduler

The Shared Memory Pool is divided in three main parts: Input/Output Ring Buffer Port (IORBP), Data Buffer (DB) and Operation Queue (OQ).

The external static scheduler (External Task Loader/Listener Pair) puts clustered instructions and data of an input program into the IORBP. The ring buffer service processes (IORBP PROC) move data into the DB and instructions into the OQ. The operation queue service processes (OQ PROC) tag the instructions as ready for execution if the required operands' data is accessible. The execution processes (CPU PROC) execute instructions, which are tagged as ready and output computed data into the DB or to the IORBP. Additionally, IORBP PROC and OQ PROC are responsible for freeing memory after contexts have been processed. The context is a special unique identifier representing a copy of data within

different iteration bodies. This allows the dynamic scheduler to handle several iterations in parallel.

In order to allow several processes accessing the same data concurrently, BMDFM locks objects in the Shared Memory Pool via POSIX/SVR4 semaphore operations. Locking policy provides multiple read-only access and exclusive access for modification.

2.3 Configuration



Caution

Please, ensure suitable amount of SVR4 IPC resources when running BMDFM (note that BMDFM can be configured with POSIX/SVR4-IPC-synchronization).

Example for SunOS:

```
/etc/system
set shmsys:shminfo_shmmax=2147483647
set semsys:seminfo_semmni=128
set semsys:seminfo_semmsl=256
set semsys:seminfo_semmns=32768
```

Configuration parameters are gathered in the BMDFM configuration profile. The configuration parameters are explained below:

SHMEM_POOL_SIZE defines maximal shared memory pool size. Bigger values ensure that BMDFM will operate for larger amounts of data. Note that 2147483647 (2GB) shmmax value is normally a limit for 32-bit mode. Run 64-bit BMDFM that allows you to configure more shared memory space.

SHMEM_POOL_MNTADDR defines explicit mounting address of the shared memory pool. By default, the mounting address is chosen by the BMDFM Server and the OS automatically.

SHMEM_POOL_PERMS defines permissions of the shared memory pool in a form of traditional Unix-like and otherwise POSIX-compliant system permissions (e.g. decimal 432 is equal to octal 0660 and means "rw-rw----").

SHMEM_POOL_BANKS defines the number of banks in shared memory pool. Several banks together work faster than one, however, the memory bank restricts maximal memory block size that can be allocated.

POSIX_SEMA4_SYNC defines whether POSIX semaphores should be used instead of SVR4 semaphores.

ARRAYBLOCK_SIZE defines the policy of the memory allocation. Memory is allocated in chunks. Bigger values cause less intensive and faster memory allocation, however at the same time, cause more inefficient memory usage.

OQ_FUNC_ARG_COUNT defines the default number of the function arguments statically allocated in the OQ. In case where the actual number of arguments exceeds, they will be allocated dynamically.

Q_OQ defines OQ size. Bigger values allow the running of tasks with more complex data dependencies, however, a big OQ requires additional memory space, an additional number of semaphores and can slow down associative searches in the dynamic scheduling subsystem.

Q_DB defines DB size. Bigger values allow running tasks with more variables, however, a big DB requires additional memory space and an additional number of semaphores.

Q_IORBP defines IORBP size. Bigger values allow more intensive loading of data via the Task Connection Zone, however, a big IORBP requires additional memory space and an additional number of semaphores.

N_IORBP defines the number of IORBPs, thus the number of tasks, which can be processed in parallel. Processing several tasks simultaneously uses system resources more efficiently.

N_TRACEPORT defines how many tracers can be attached at the same time. Bigger values allow one to have more tracers working in separate windows displaying different resources.

N_CPUPROC defines the number of CPUPROC processes. Usually, it makes sense to set this value equal or doubled to the number of system logical processors (processors * cores * threads_per_core). An additional tuning can be done after analysis of STALL WARNINGS in the generated log files.

N_OQPROC defines the number of OQPROC processes. Usually, it makes sense to set this value equal or doubled to the number of system logical processors (processors * cores * threads_per_core). An additional tuning can be done after analysis of STALL WARNINGS in the generated log files.

N_IORBPPROC defines the number of IORBPROC processes. Usually, it makes sense to set this value equal or doubled to the number of system logical processors (processors * cores * threads_per_core). An additional tuning can be done after analysis of STALL WARNINGS in the generated log files.

CPUPROC_MTHREAD specifies multithreading model (if switched on) or multi-process model (if switched off) for the CPUPROC processes.

OQPROC_MTHREAD specifies multithreading model (if switched on) or multi-process model (if switched off) for the OQPROC processes.

IORBPPROC_MTHREAD specifies multithreading model (if switched on) or multi-process model (if switched off) for the IORBPROC processes.

BMDFMLDR_MTHREAD specifies multithreading model (if switched on) or multi-process model (if switched off) for the BMDFMLdr static scheduler processes.

MTHREAD_TLS_CHECK switches verification for Thread-Local Storage (TLS) on/off. The verification is done at startup.

ALLOW_CPUPROC_ASLR allows CPUPROC processes to use Address Space Layout Randomization (ASLR) provided by the OS (if switched on).

T_STATISTIC defines time interval between attempts of collecting statistics. Less values make the statistics more precise but increase costs for this.

PROC_HEARTBEATS switches process heartbeats on/off. The heartbeats are sent between CPUPROC, OQPROC and IORBPROC processes in order to detect whether the processes are alive.

DFSTLHAZARD_DETECT switches detection of dataflow stall hazards on/off. All stalled dataflow instructions will be purged after a stall hazard is detected.

ALLOW_DROP_NONPROD allows dropping nonproductive instructions (if switched on). Nonproductive instructions are those that do not influence any execution path for achieving results of an application program (the results of an application program are VM native inputs and outputs of this application program).

PROC_CPU_LOGS switches Data Flow Logging Facility on/off. This facility allows logging the CPUPROC and IORBPROC process activities into log files.

HARD_ARRAY_SYNCHRO ensures correct array processing where the multiple assignments are applied to the same array members. As a rule, the BMDFM system asks to switch this option on if it is necessary.

EXT_IN_OUT_SYNCHRO synchronizes console messages that are generated by the Loader/Listener Pair. If this configuration parameter is switched on, the Loader always waits until the Listener releases console.

OQ_DB_SEM_LIMIT defines the maximal allowed number of SVR4 semaphores in the OS kernel that are owned by the BMDFM instance. By default, no limitation is set. Note that BMDFM can be configured with POSIX/SVR4-IPC-synchronization.

RELAXED_CNSTN_SM_MODEL compensates relaxed consistency model of shared memory (if switched on). The compensation mechanisms are activated by default. It is strongly recommended to keep them activated if the consistency model of SMP machine is not clear enough.

DEFOP configures user-defined functions to be loaded into CPUPROC local memory.

Figure 2-4 shows configuration example for a 1024-way SMP machine.

```

SHMEM_POOL_SIZE      = 10995116277760 # (10TB) Shared memory pool size [Bytes]
SHMEM_POOL_MNTADDR  = 0 # ShMemPool mount address (0=auto)
SHMEM_POOL_PERMS    = 432 # ShMemPool permissions (0660=="rw-rw-")
SHMEM_POOL_BANKS    = 500 # Number of banks in pool
POSIX_SEMA4_SYNC    = RW+Count # Replace None/RW/RW+Count SVR4 with POSIX sema4
ARRAYBLOCK_SIZE     = 64 # Array block size [Entities]
OQ_FUNC_ARG_COUNT   = 32 # OQ functions arguments count [Entities]

Q_OQ                 = 50000 # Operation Queue (OQ) size [Entities]
Q_DB                 = 10000 # Data Buffer (DB) size [Entities]
Q_IORBP              = 1000 # I/O Ring Buffer Port (IORBP) size [Entities]
N_IORBP              = 10 # Number of the IORBPs
N_TRACEPORT          = 5 # Number of the Trace Ports (TPs)

N_CPUPROC            = 2048 # Number of the CPU PROCs
N_OQPROC              = 2048 # Number of the OQ PROCs
N_IORBPPROC          = 2048 # Number of the IORBP PROCs

CPUPROC_MTHREAD      = No # CPU PROC is multithreaded
OQPROC_MTHREAD       = No # OQ PROC is multithreaded
IORBPPROC_MTHREAD    = No # IORBP PROC is multithreaded
BMDFMLDR_MTHREAD     = No # BMDFMLdr is multithreaded

MTHREAD_TLS_CHECK    = No # Check for Thread-Local Storage (TLS)
ALLOW_CPUPROC_AS LR = No # Allow CPU PROC Address Space Layout
                        # Randomization (ASLR)

T_STATISTIC          = 1 # Time to scan DFM for statistic [Seconds]
PROC_HEARTBEATS       = Yes # Heartbeats for the CPU, OQ && IORBP PROCs
DFSTLHAZARD_DETECT   = Yes # Detection of dataflow stall hazards
ALLOW_DROP_NONPROD   = No # Allow dropping nonproductive instructions
PROC_CPU_LOGS         = No # Logs registration for the CPU && IORBP PROCs
HARD_ARRAY_SYNCHRO   = No # Hard synchronization of the arrays
EXT_IN_OUT_SYNCHRO   = Yes # I/O synchronization of external task
OQ_DB_SEM_LIMIT      = 0 # Max number of OQ&&DB semaphores (0=unlim.)

DEFOP                 = (defun true (progn 1))
                       (defun false (progn 0))
                       # (defun ...)

```

Figure 2-4. Configuration example for a 1024-way SMP machine

2.4 Top Screen of the Running System

The *top* screen of the running BMDFM is shown in [Figure 2-5](#). It clearly demonstrates that BMDFM is built according to the **MIMD architecture** and has **negligible dynamic scheduling overhead!**

```

Terminal
Window Edit Options Help
load averages:  5.16,  5.32,  5.34                               16:13:58
88 processes:  81 sleeping,  2 running,  1 zombie,  4 on cpu
CPU states:  0.0% idle,  98.1% user,  1.9% kernel,  0.0% iowait,  0.0% swap
Memory:  2048M real,  601M free,  2060M swap in use,  1400M swap free

  PID USERNAME  THR  PRI  NICE  SIZE  RES  STATE  TIME  CPU  COMMAND
13362 sancho      1   30    0 1909M  870M  cpu1  170:11 19.56% CPUPROC
13359 sancho      1   20    0 1909M  870M  run   170:31 19.56% CPUPROC
13361 sancho      1   20    0 1909M  870M  cpu2  169:59 19.16% CPUPROC
13363 sancho      1   20    0 1909M  870M  cpu0  169:59 19.16% CPUPROC
13360 sancho      1   20    0 1909M  870M  run   169:52 18.48% CPUPROC
13366 sancho      1   58    0 1908M   19M  sleep  1:31  0.18% OQPROC
13367 sancho      1   58    0 1908M   19M  sleep  1:33  0.16% OQPROC
13373 sancho      1   58    0 1908M   19M  sleep  1:33  0.15% OQPROC
13368 sancho      1   58    0 1908M   19M  sleep  1:29  0.14% OQPROC
13372 sancho      1   58    0 1908M   19M  sleep  1:28  0.14% OQPROC
13365 sancho      1   58    0 1908M   19M  sleep  1:34  0.13% OQPROC
13371 sancho      1   58    0 1908M   19M  sleep  1:31  0.13% OQPROC
13370 sancho      1   58    0 1908M   19M  sleep  1:30  0.13% OQPROC
13364 sancho      1   58    0 1908M   19M  sleep  1:35  0.12% OQPROC
13369 sancho      1   58    0 1908M   19M  sleep  1:24  0.12% OQPROC
16419 sancho      1   58    0 1592K 1240K  cpu3   0:00  0.11% top
13375 sancho      1   58    0 1908M   20M  sleep  0:23  0.05% IORBPROC
13377 sancho      1   58    0 1908M   20M  sleep  0:23  0.05% IORBPROC
13374 sancho      1   58    0 1908M   20M  sleep  0:23  0.05% IORBPROC
13376 sancho      1   58    0 1908M   20M  sleep  0:23  0.04% IORBPROC
13381 sancho      1   58    0 1908M   19M  sleep  0:23  0.04% IORBPROC
16416 sancho      1   58    0 1909M 3968K  sleep  0:03  0.04% BMDFMldr
13378 sancho      1   58    0 1908M   21M  sleep  0:23  0.03% IORBPROC
16411 sancho      1   58    0 1909M 7400K  sleep  0:07  0.03% BMDFMldr
13379 sancho      1   58    0 1908M   19M  sleep  0:23  0.03% IORBPROC
13380 sancho      1   58    0 1908M   20M  sleep  0:22  0.02% IORBPROC
16406 sancho      1   58    0 1909M 3928K  sleep  0:03  0.02% BMDFMldr
13357 sancho      1   58    0 1909M 2696K  sleep  0:05  0.00% BMDFMsrv
16378 sancho      1   35    0 1032K  824K  sleep  0:00  0.00% Batch_zz
16374 sancho      1   35    0 1032K  824K  sleep  0:00  0.00% Batch_zz
16370 sancho      1   35    0 1032K  824K  sleep  0:00  0.00% Batch_zz
16407 sancho      1   58    0 1909M 1512K  sleep  0:00  0.00% BMDFMldr
16412 sancho      1   58    0 1909M 1488K  sleep  0:00  0.00% BMDFMldr
16417 sancho      1   58    0 1909M 1360K  sleep  0:00  0.00% BMDFMldr
13384 sancho      1   58    0 1552K 1264K  sleep  0:00  0.00% csh
13408 sancho      1   58    0 1552K 1264K  sleep  0:00  0.00% csh
13431 sancho      1   58    0 1552K 1264K  sleep  0:00  0.00% csh
13330 sancho      1   58    0 1552K 1264K  sleep  0:00  0.00% csh
13453 sancho      1   58    0 1552K 1264K  sleep  0:00  0.00% csh
13358 sancho      1   58    0 1908M  824K  sleep  0:00  0.00% PROCstat

```

Figure 2-5. BMDFM running on a 4-way SMP machine

This page is intentionally left blank.

Chapter 3

Installation and Use

3.1 Structure of Modules on the Disk

BMDFM modules shown in [Figure 3-1](#). All modules are given as executables and some of them additionally as object files and sources. Recompilation is necessary only if a new application (interface and implementation) is written in C/C++. Singlethreaded version of BMDFM consists of only one module, all the rest belongs to the multithreaded engine. The multithreaded BMDFM starts with the BMDFMsrv server, which automatically starts multiple copies of the daemons (CPUPROC, OQPROC, IORBPROC and PROCstat). The BMDFMldr, BMDFMtrc and freeIPC (as well as the fastlisp and BMDFMsrv themselves) are standalone utilities.

<code>cflp_udf.h</code>	<code>cflp_udf.c</code>	<i>User applications interface and implementation</i>
<code>Makefile</code>		<i>Build file</i>
<code>fastlisp.o</code>	<code>fastlisp</code>	<i>BMDFM singlethreaded engine</i>
<code>BMDFMsrv.o</code>	<code>BMDFMsrv</code>	<i>BMDFM multithreaded engine server unit</i>
<code>CPUPROC.o</code>	<code>CPUPROC</code>	<i>CPU PROC daemon</i>
	<code>OQPROC</code>	<i>OQ PROC daemon</i>
	<code>IORBPROC</code>	<i>IORBPROC PROC daemon</i>
	<code>PROCstat</code>	<i>Daemon that collects statistic information</i>
<code>BMDFMldr.o</code>	<code>BMDFMldr</code>	<i>External task unit (Loader/Listener Pair)</i>
	<code>BMDFMtrc</code>	<i>External Tracer unit</i>
	<code>freeIPC</code>	<i>Utility that releases system IPC resource after crash</i>

Figure 3-1. BMDFM modules

Normally, the BMDFM files are gathered in a `$BMDFM_HOME/` working directory. The directory structure is shown in [Figure 3-2](#). Choose a BMDFM build by linking Bin directory to the right target directory (default link is `Bin -> Build/x86_Linux_32/`), e.g.: `rm Bin; ln -s Build/x86-64_Linux_64/ Bin`

```

$BMDFM_HOME/
  EULA.txt
  READ ME.1ST
  Doc/
    BMDFMmission.pdf    BMDFMdoc.pdf    BMDFMfaq.pdf
    <Examples>/
  Bin/ -> Build/x86_Linux_32/
  fastlisp      -> Bin/fastlisp
  BMDFMsrv     -> Bin/BMDFMsrv
  CPUPROC      -> Bin/CPUPROC
  OQPROC       -> Bin/OQPROC
  IORBPROC     -> Bin/IORBPROC
  PROCstat     -> Bin/PROCstat
  BMDFMldr     -> Bin/BMDFMldr
  BMDFMtrc     -> Bin/BMDFMtrc
  freeIPC      -> Bin/freeIPC
  fastlisp.cfg -> Bin/fastlisp.cfg
  BMDFMsrv.cfg -> Bin/BMDFMsrv.cfg
  Build/
    x86_Windows_32/
    x86_Windows-Cygwin_32/
    x86_Windows-UWIN_32/
    x86_Windows-SFU-SUA_32/
    x86_Linux_32/
    x86_Linux_32_clang/
    x86_Linux_32_icc/
    x86_FreeBSD_32/
    x86_FreeBSD_32_clang/
    x86_OpenBSD_32/
    x86_NetBSD_32/
    x86_MacOS_32/
    x86_SunOS_32/
    x86_SunOS_32_gcc/
    x86_UnixWare_32/
    x86_UnixWare_32_gcc/
    x86_Minix_32/
    x86_Android_32/
    x86_Android_32_clang/
    x86-64_Windows-Cygwin_64/
    x86-64_Linux_64/
    x86-64_Linux_64_clang/
    x86-64_Linux_64_icc/
    x86-64_FreeBSD_64/
    x86-64_FreeBSD_64_clang/
    x86-64_OpenBSD_64/
    x86-64_NetBSD_64/
    x86-64_MacOS_64/
    x86-64_SunOS_64/
    x86-64_SunOS_64_gcc/
    x86-64_Android_64/
    x86-64_Android_64_clang/
    VAX_Ultrix_32/
    Alpha_Tru64OSF1_64/
    Alpha_Linux_64/
    Alpha_FreeBSD_64/
    IA-64_HP-UX_32/
    IA-64_HP-UX_32_gcc/
    IA-64_HP-UX_64/
    IA-64_HP-UX_64_gcc/
    IA-64_Linux_64/
    IA-64_FreeBSD_64/
    XeonPhiMIC_Linux_64/
    XeonPhiMIC_Linux_64_gcc/
    MCSTelbrus_Linux_32/
    MCSTelbrus_Linux_64/
    PA-RISC_HP-UX_32/
    PA-RISC_HP-UX_32_gcc/
    PA-RISC_HP-UX_64/
    PA-RISC_HP-UX_64_gcc/
    PA-RISC_Linux_32/
    SPARC_SunOS_32/
    SPARC_SunOS_32_gcc/
    SPARC_SunOS_64/
    SPARC_SunOS_64_gcc/
    SPARC_Linux_32/
    SPARC_Linux_64/
    SPARC_Linux_64_clang/
    SPARC_FreeBSD_64/
    MIPS_IRIX_32/
    MIPS_IRIX_32_gcc/
    MIPS_IRIX_64/
    MIPS_IRIX_64_gcc/
    MIPS_Linux_32/
    MIPS_Linux_64/
    MIPSel_Linux_32/
    MIPSel_Linux_64/
    MIPSel_Android_32/
    MIPSel_Android_32_clang/
    MIPSel_Android_64/
    MIPSel_Android_64_clang/
    PowerPC_AIX_32/
    PowerPC_AIX_32_gcc/
    PowerPC_AIX_64/
    PowerPC_AIX_64_gcc/
    PowerPC_MacOS_32/
    PowerPC_MacOS_64/
    PowerPC_Linux_32/
    PowerPC_Linux_32_clang/
    PowerPC_Linux_64/
    PowerPC_Linux_64_clang/
    PowerPC_FreeBSD_32/
    PowerPC_FreeBSD_32_clang/
    PowerPC_FreeBSD_64/
    PowerPC_FreeBSD_64_clang/
    PowerPcle_Linux_32/
    PowerPcle_Linux_64/
    PowerPcle_Linux_64_clang/
    PowerPcle_Linux_64_xlC/
    S390_Linux_32/
    S390_Linux_64/
    S390_Linux_64_clang/
    M68000_Linux_32/
    ARM_Linux_32/
    ARM_Linux_32_eabi/
    ARM_Linux_32_eabihf/
    ARM_Linux_32_eabihfclang/
    ARM_Linux_64/
    ARM_Linux_64_clang/
    ARM_Android_32/
    ARM_Android_32_clang/
    ARM_Android_64/
    ARM_Android_64_clang/
    ARMbe_Linux_64/
    RISC_V_Linux_64/
    ...
    <Arch>_<OS>_<WordWidth>[_<Feat.>]/
  cflp_udf.h      fastlisp.o      fastlisp      OQPROC
  cflp_udf.c      BMDFMsrv.o    BMDFMsrv     IORBPROC
  Makefile        CPUPROC.o     CPUPROC      PROCstat
  fastlisp.cfg    BMDFMldr.o   BMDFMldr     freeIPC
  BMDFMsrv.cfg   BMDFMtrc     BMDFMtrc

```

Figure 3-2. BMDFM directory tree

3.2 Programming and Compilation

Normally, the life cycle of a BMDFM user application has two major steps as shown in [Figure 3-3](#). At first the application is developed and tested using the BMDFM singlethreaded engine, then if it works properly it can be moved without any modifications to the BMDFM multithreaded engine.

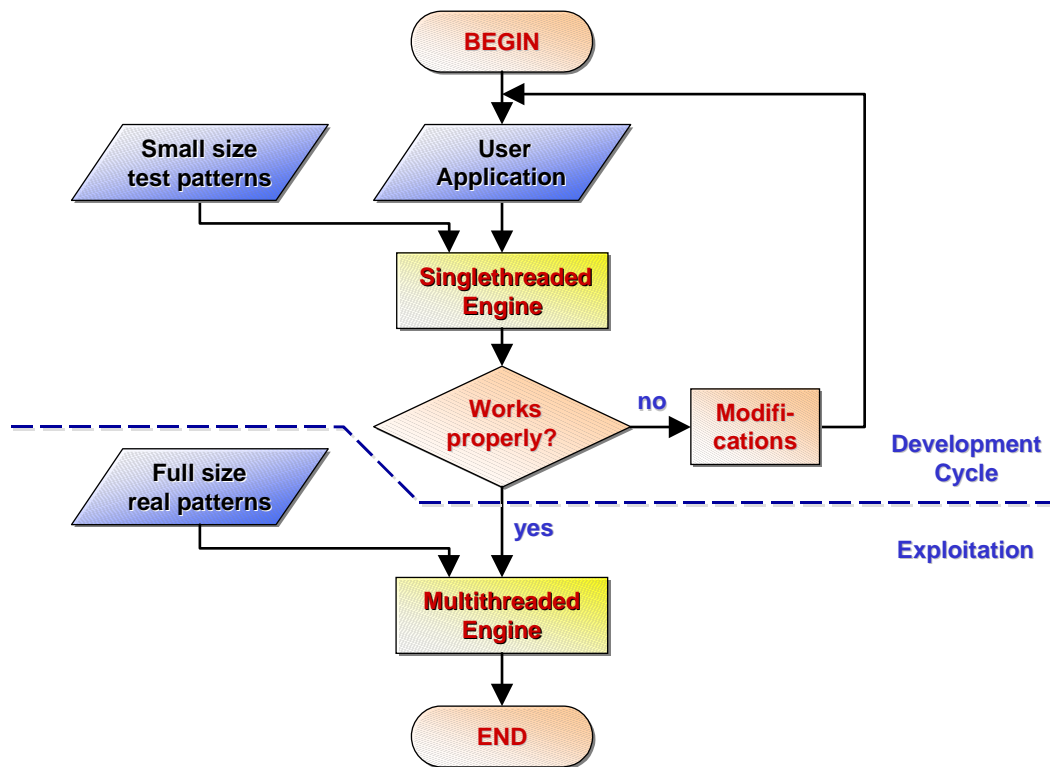

Figure 3-3. BMDFM user application life cycle

A BMDFM user application itself can be built according to the three schemes in [Figure 3-4](#) (actually, the application can be structured as any combination of these three schemes).

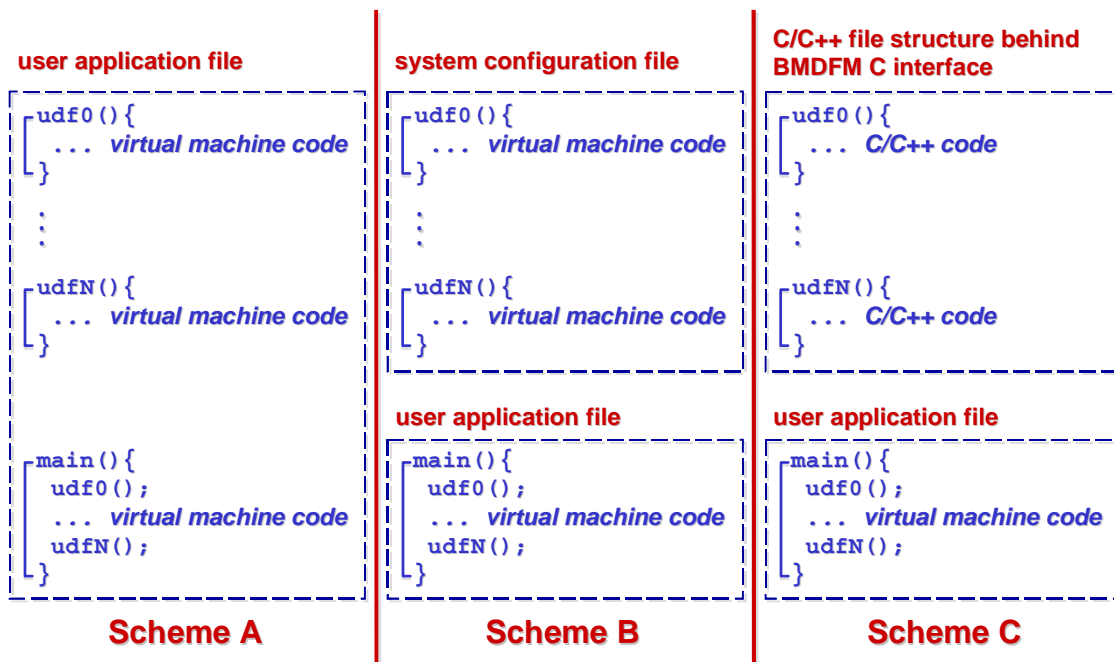

Figure 3-4. BMDFM user application structure

Scheme A. A complete application is written in pure virtual machine language. In this case BMDFM will exploit fine-grain parallelism, thus BMDFM will try to unroll the loops and to execute all statements in parallel. If it runs on a non-UMA (non-Uniform Memory Access) machine the dynamic scheduling can be expensive.

Scheme B. According to this scheme some UDFs (User Defined Functions) are located in the configuration profile, thus BMDFM will upload them into CPU PROCs Local Memory and their bodies will be prevented from scheduling for parallel processing (such a UDF will be treated as one seamless statement). In this case less time is obviously spent on dynamic scheduling.

Scheme C. This scheme enables using the C code directly instead of the virtual machine code. Of course the C code compiled and optimized by a local C compiler is faster than virtual machine code. In this case some BMDFM modules should be recompiled as shown in [Figure 3-5](#).

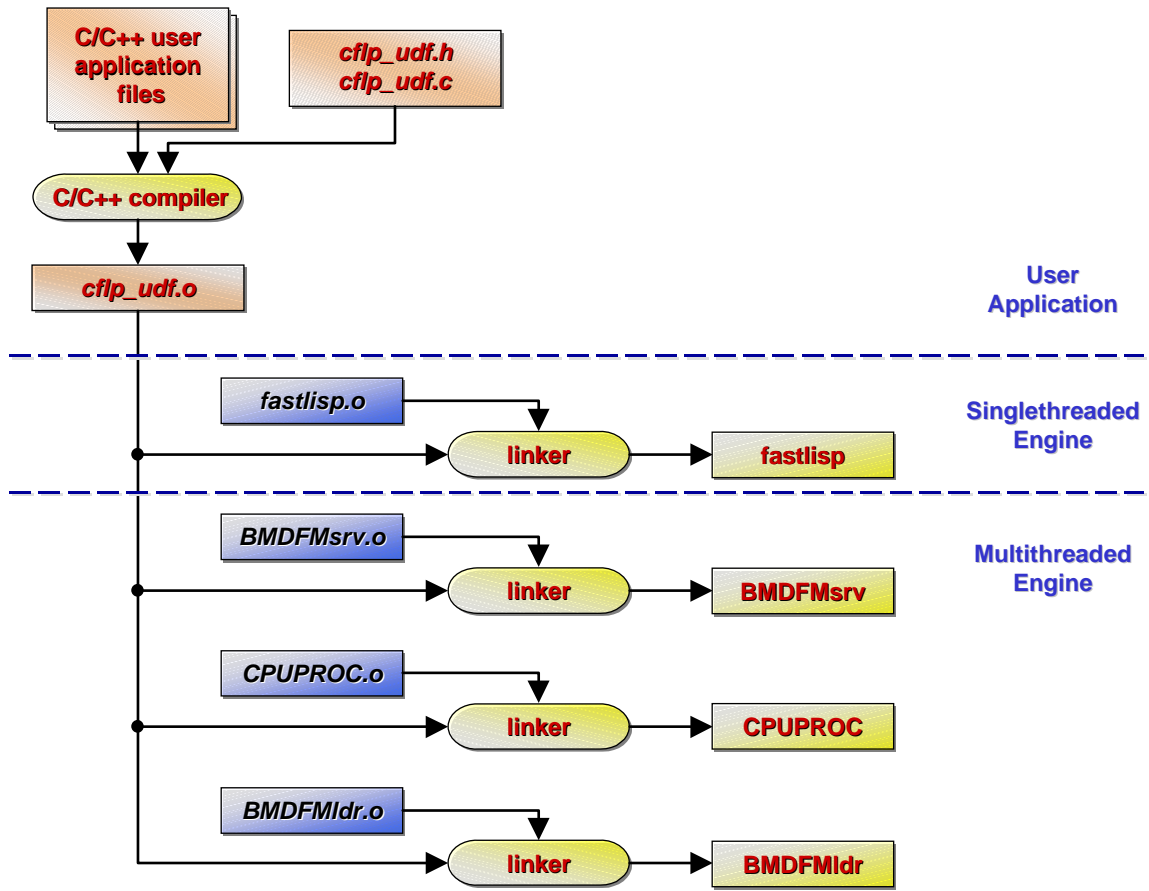

Figure 3-5. Recompilation of the BMDFM modules

3.3 Singlethreaded Engine

The BMDFM singlethreaded engine can be used from a command line according to the syntax shown in [Figure 3-6](#). The help option creates a documentation file and a set of examples on the disk. The compile2disk option creates a machine dependent compiled code of the application on the disk. Optionally, the environment variable defines location of the configuration profile.

```
Usage0: fastlisp -h|--help
Usage1: fastlisp -V|--versions
Usage2: fastlisp [-q|--quiet] <FastLisp_file_name> [args...]
Usage3: fastlisp [-c|--compile2disk] <FastLisp_file_name> [args...]
Usage4: fastlisp [-q|--quiet] <Precompiled_FastLisp_file_name>
```

The following environment variable:

```
FAST_LISP_CFGPROFILE_path="fastlisp.cfg"
specifies a configuration profile that can be used for the Global FastLisp
function definitions. The format of the configuration profile is:
<(DEFUN ...)>{ <(DEFUN ...)>} # <EOF>.
```

Figure 3-6. BMDFM singlethreaded engine command line syntax

The BMDFM singlethreaded engine compiles, links and runs a user application in a standalone mode as shown in [Figure 3-7](#).

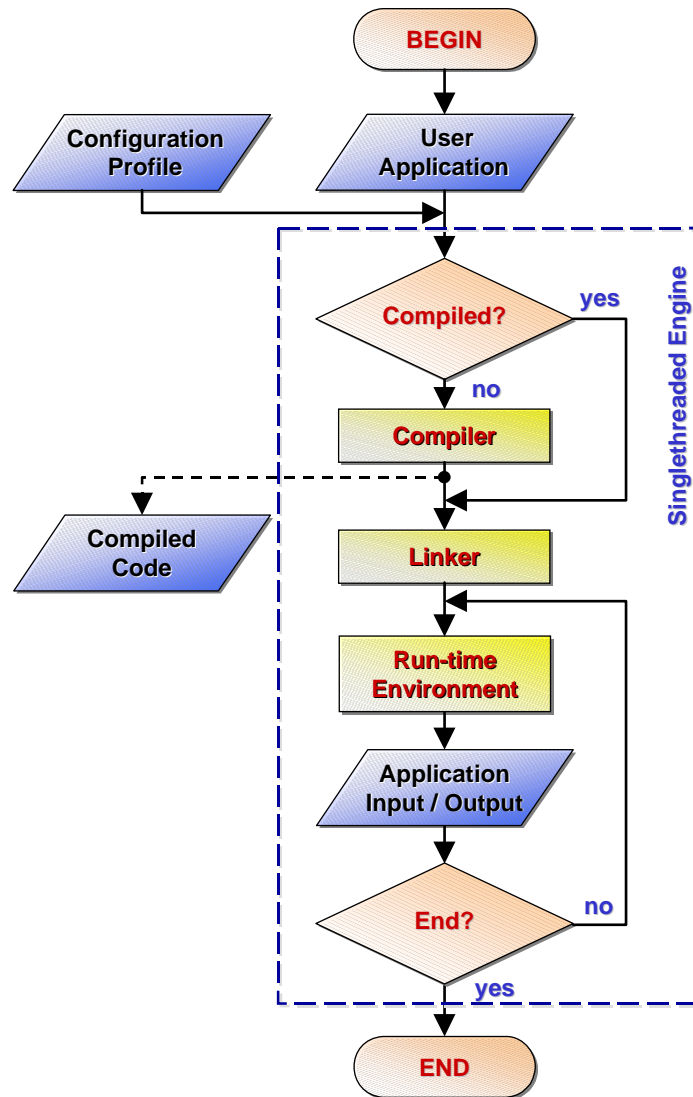

Figure 3-7. BMDFM singlethreaded engine work flow

3.4 Server Unit

There is only one way to start the BMDFM multithreaded engine correctly. It should be started by the BMDFM Server from a command line according to the syntax shown in [Figure 3-8](#). The BMDFM Server may also run as a daemon. Additional logfile options enable/disable logging of console information on the disk. Optionally, the environment variables define locations of all the daemons, which will be started in the background, and further configuration parameters.

```
Usage0: BMDFMsrv [-d|--daemonize]
Usage1: BMDFMsrv -h|--help
Usage2: BMDFMsrv [-d|--daemonize] -n|--no-logs
Usage3: BMDFMsrv [-d|--daemonize] -l|--logfile <log_file_name>

Runtime environment variable dump:
BM_DFM_CFGPROFILE_path="./BMDFMsrv.cfg";
BM_DFM_PROCstat_path="./PROCstat";
BM_DFM_CPUPROC_path="./CPUPROC";
BM_DFM_OQPROC_path="./OQPROC";
BM_DFM_IORBPROC_path="./IORBPROC";
BM_DFM_CONNECTION_FILE_path="/tmp/.BMDFMsrv";
BM_DFM_CONNECTION_NPIP_path="/tmp/.BMDFMsrv_npipe";
BM_DFM_EMERGENCY_IPC_FILE_path="./freeIPC.inf";
BM_DFM_LOGFILE_KEEP_NxSIZE="10x10000000";
BM_DFM_PROCLOGFILE_KEEP_NxSIZE="10x10000000";
BM_DFM_PROCLOGFILE_path="./PROCs.log";
```

Figure 3-8. BMDFM Server command line syntax

The BMDFM Server unit reads the configuration profile, initializes the Shared Memory Pool, starts multiple copies of the daemons in the background and enters a console mode. The BMDFM Server unit is also responsible for shutting down the whole multithreaded engine correctly. This procedure is illustrated in [Figure 3-9](#). A screen shot of the BMDFM Server console, when it operates typical routines, is shown in [Figure 3-10](#).

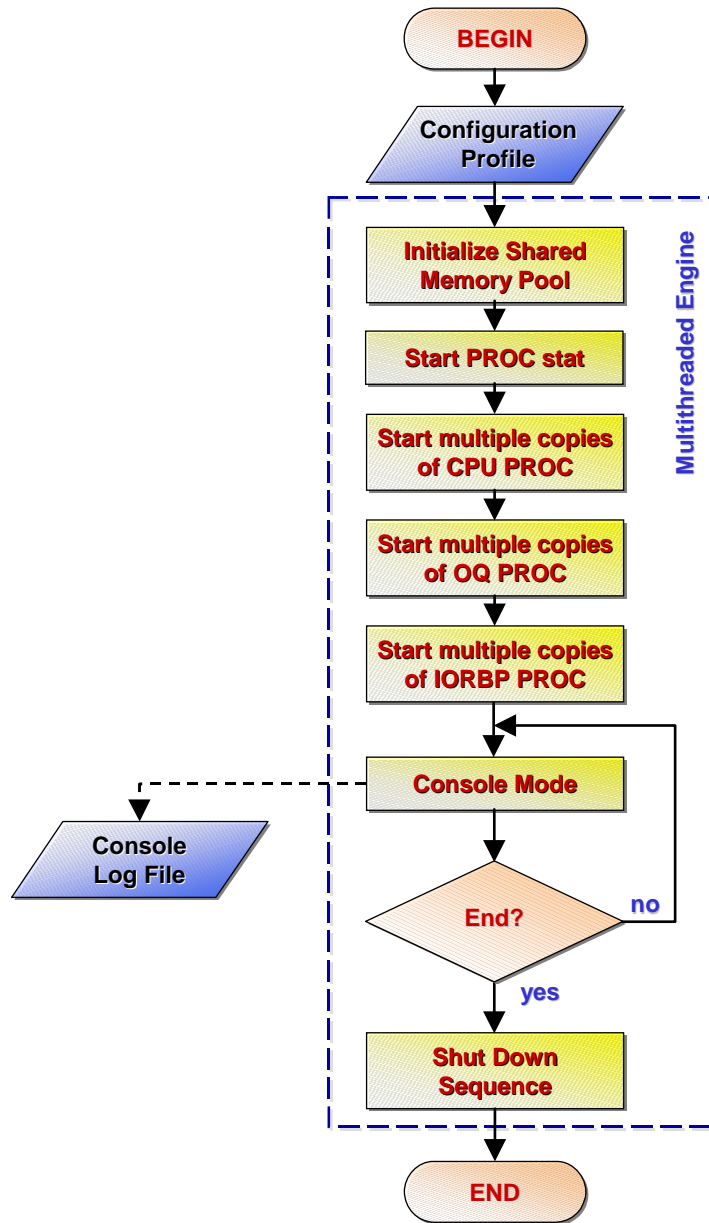

Figure 3-9. BMDFM Server unit work flow

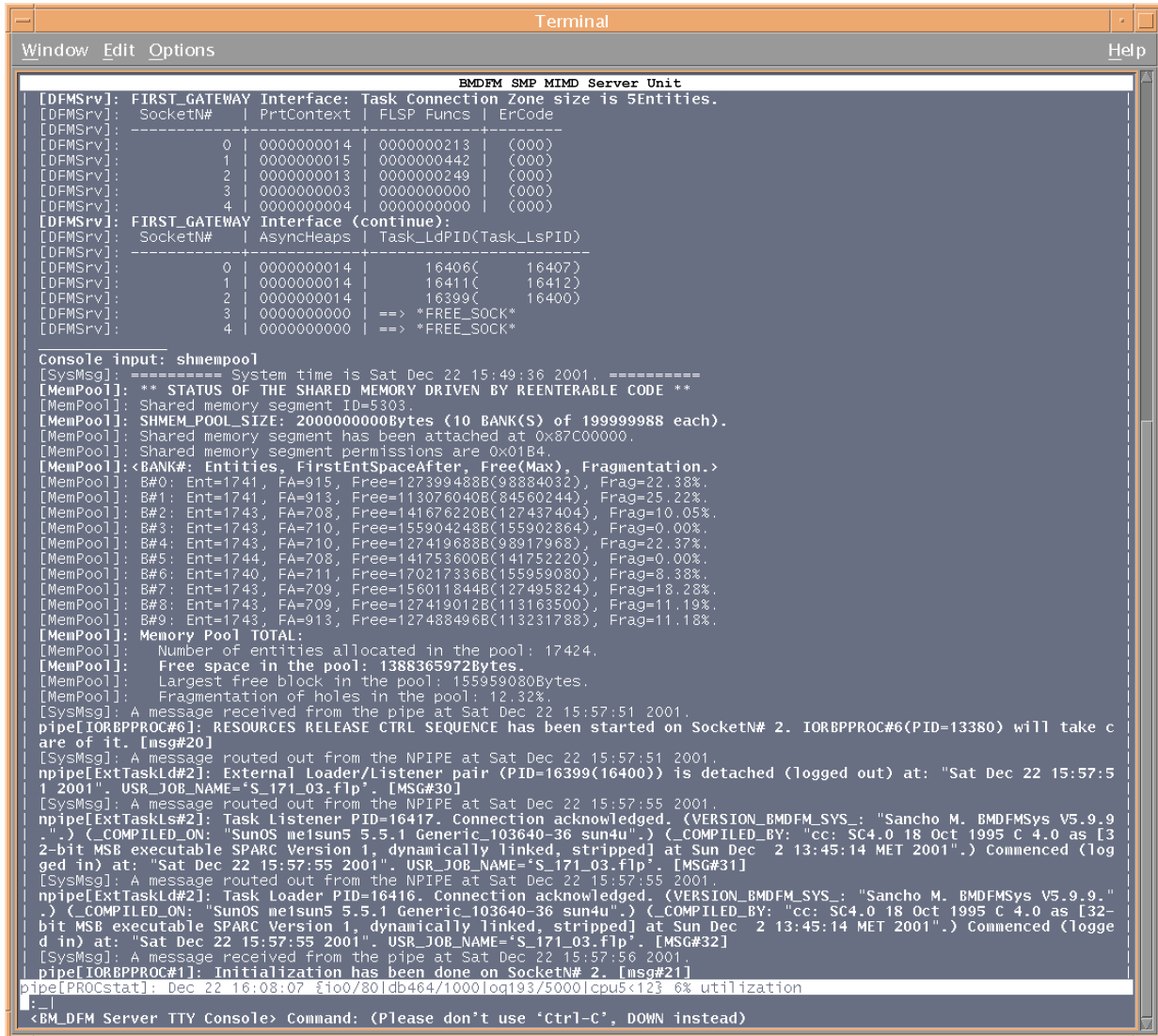

Figure 3-10. BMDFM Server console view

3.5 External Task Unit

The external task unit (Loader/Listener Pair) can be used from a command line according to the syntax shown in [Figure 3-11](#). The `compile2disk` option creates a machine dependent compiled code of the application on the disk. Optionally, the environment variables define connection pathes to a BMDFM Server running instance.

```
Usage0: BMDFMldr -h|--help
Usage1: BMDFMldr -V|--versions
Usage2: BMDFMldr [-q|--quiet] <FastLisp_file_name> [args...]
Usage3: BMDFMldr [-c|--compile2disk] <FastLisp_file_name> [args...]
Usage4: BMDFMldr [-q|--quiet] <Precompiled_FastLisp_file_name>

Runtime environment variable dump:
BM_DFM_CONNECTION_FILE_path="/tmp/.BMDFMsrv";
BM_DFM_CONNECTION_NPIP_path="/tmp/.BMDFMsrv_npipe";
```

Figure 3-11. External task unit command line syntax

The external task unit reorganizes the user code, makes static scheduling, compiles, connects multithreaded engine, links, starts listener thread and uploads the user application into the multithreaded engine as shown in [Figure 3-12](#).

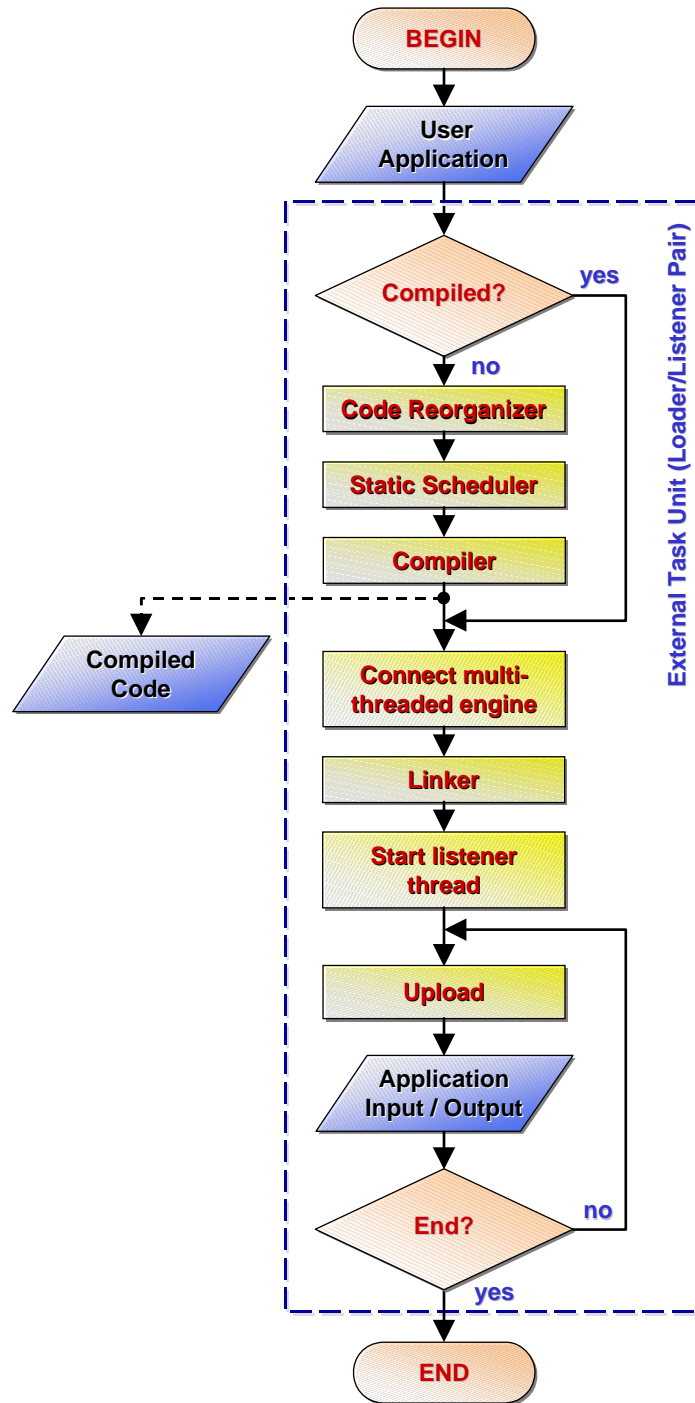

Figure 3-12. External task unit work flow

3.6 External Tracer Unit

The external tracer unit can be used from a command line according to the syntax shown in [Figure 3-13](#). Additional logscreen options enable/disable information logging on the disk. Optionally, the environment variables define connection pathes to a BMDFM Server running instance.

```
Usage0: BMDFMtrc
Usage1: BMDFMtrc -h|--help
Usage2: BMDFMtrc -l|--log-screen [<log_file_name>]

Runtime environment variable dump:
BM_DFM_CONNECTION_FILE_path="/tmp/.BMDFMsrv";
BM_DFM_CONNECTION_NPIP_path="/tmp/.BMDFMsrv_npipe";
```

Figure 3-13. External tracer unit command line syntax

The external tracer unit connects the multithreaded engine and enters the tracer console as shown in [Figure 3-14](#). A screen shot of the external tracer console is shown in [Figure 3-15](#).

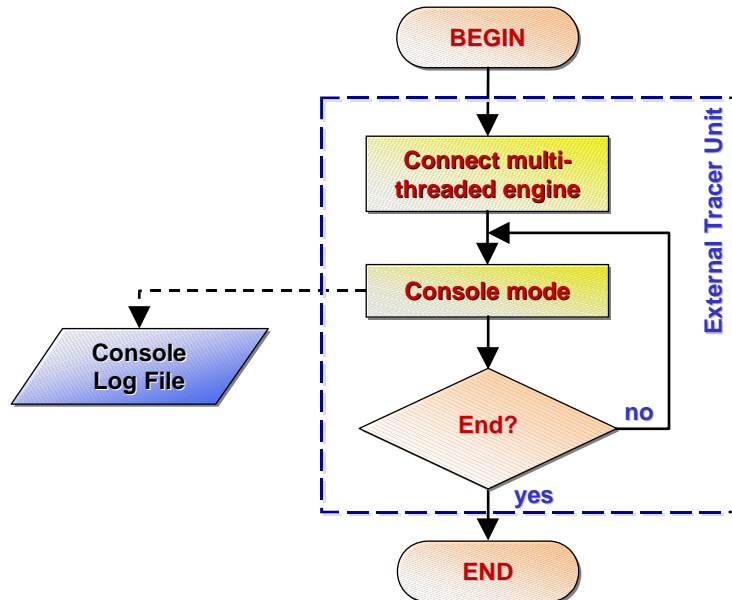

Figure 3-14. External tracer unit work flow

Appendix A

Programming Language Reference

The BMDFM virtual machine language is based on a prefix form syntax and uses **transparent dataflow semantics**.

A.1 Program

A program is a function:

```
"<FuncName>"  
(<FuncName> <Val_argument1> <Val_argument2> ... <Val_argumentN>)  
--> <Val_calculated_value>
```

It returns its calculated value as a result. It is possible to specify a formal argument, a constant value, a variable name or some other function at the place of the function argument. Formal arguments appear like \$1 ... \$N. All argument types will be automatically converted to the required types when the function is called.

`#' is a comment symbol. It indicates that all text following the `#' symbol (until the carriage return) is a comment. All symbols in the same line after the `#' symbol will be ignored.

A.2 Constant definition

Integer constants:

```
[<+|->]<digit>[<{>}<digit>]
```

Float constants:

```
[<+|->][<{>}<digit>][. <{>}<digit>][e [<+|->] <{>}<digit>]
```

String constants:

```
"<char>{<char>}"  
Special symbols are:  
\a - beep;  
\b - back space;  
\e - escape;  
\f - page feed;  
\n - new line;  
\r - return;  
\t - tab;  
\v - vertical tab;  
\ - \  
\" - "  
\0xNN - symbol by its hex code (e.g.: \0x25 == `%', \0x5C == `\'').
```

Special void type constant:

```
nil
```

A.3 Variables

Variable names are not case sensitive. A variable name starts with a letter followed by letters, numbers and other symbols except '@' and ':' symbols. Variables change their types dynamically among integers, floats, strings and nil.

Boolean 'TRUE' is considered to be an integer non-zero value.

Boolean 'FALSE' is considered to be an integer zero value.

A variable can also be an array. An array changes its size (number of members) dynamically. Array members can be integers, floats, strings, NIL's and arrays themselves that allows one creating list and tree structures.

First(zero) array member cannot be an array itself.

Predefined terminal control variables (same names like the corresponding terminal capabilities functions) are:

Variable Name	Type	Value
TERM_TYPE	String	<'TERM'_environment>
LINES_TERM	Integer	<termcap(li)>
COLUMNS_TERM	Integer	<termcap(co)>
CLRSCR_TERM	String	<termcap(cl)>
REVERSE_TERM	String	<termcap(mr)>
BLINK_TERM	String	<termcap(mb)>
BOLD_TERM	String	<termcap(md)>
NORMAL_TERM	String	<termcap(me)>
HIDECURSOR_TERM	String	<termcap(vi)>
SHOWCURSOR_TERM	String	<termcap(ve)>
GOTOCURSOR_TERM	String	<termcap(cm)>

Variable assignment and index functions:

```
"setq" "asetq"  
(setq <VarName> <Val_to_be_assigned_single_value_or_array>)  
--> <Val_assigned_single_value_or_array>
```

```
"arsetq"  
(arsetq <VarName> <IVal_index>  
        <Val_to_be_assigned_single_value_or_array>)  
--> <Val_assigned_single_value_or_array>
```

```
"index"  
(index <VarName> <IVal_index>)  
--> <Val_array_member_value_by_array_member_index>
```

```
"alindex"  
(alindex <VarName> <IVal_indices>)  
--> <Val_array_of_values_by_number_of_indices>
```

A.4 Special construction functions

Argument types will be casted.

Ordered grouping:

```
"progn"  
  (progn <Val_to_be_evaluated_value1> <Val_to_be_evaluated_value2>  
        ... <Val_to_be_evaluated_valueN>)  
  --> <Val_evaluated_valueN>
```

Conditional execution:

```
"if"  
  (if <IVal_condition> <Val_to_be_evaluated_if_true>  
      <Val_to_be_evaluated_if_false>)  
  --> <Val_evaluated_on_true_or_false>
```

While-loop:

```
"while"  
  (while <IVal_condition> <Val_to_be_evaluated_while_true>)  
  --> <IVal_0>
```

For-loop:

```
"for"  
  (for <VarName_control_variable> <IVal_start_value>  
      <IVal_increment> <IVal_end_value>  
      <Val_to_be_evaluated_iteratively>)  
  --> <IVal_0>
```

User Defined Function (UDF). UDF names are not case sensitive. A UDF name may consist of letters, numbers and other symbols except '@' and ':' symbols. A UDF can be nested inside of another UDF. Formal arguments appear like \$1 ... \$N in the UDF body. A UDF may access only its private local variables, or in other words, all variables that are referenced in the UDF body are private local variables of this UDF.

```
"defun"  
  (defun <FuncName> <Val_to_be_evaluated>)  
    --> <SVal_empty_string>
```

Break iteration loop or UDF execution of the current nested level:

```
"break"  
  (break)  
    --> <SVal_empty_string>
```

Cancel program execution and exit:

```
"exit"  
  (exit)  
    --> <SVal_empty_string>
```

A.5 Input/Output functions

Argument types will be casted:

```
"accept"  
(accept <SVal_prompt_message_for_console_or_empty_for_stdin>  
--> <SVal_input_string>
```

```
"scan_console"  
(scan_console <IVal_wait_key_forever_if_1_or_useconds_if_positive>  
--> <SVal_keypressed_string>
```

```
"outf"  
(outf <SVal_printf_format> <Val_value>  
--> <SVal_printf_formatted_string_that_was_printed_to_stdout>
```

```
"file_create"  
(file_create <SVal_file_name>  
--> <IVal_file_descriptor_or_-1>
```

```
"file_open"  
(file_open <SVal_file_name>  
--> <IVal_file_descriptor_or_-1>
```

```
"file_write"  
(file_write <IVal_file_descriptor> <SVal_string_to_be_written>  
--> <IVal_number_of_bytes_written_or_-1>
```

```
"file_read"  
(file_read <IVal_file_descriptor> <IVal_number_of_bytes_to_be_read>  
--> <SVal_string_read_or_empty_string>
```

```
"file_seek_beg"  
(file_seek_beg <IVal_file_descriptor>  
  <IVal_offset_in_bytes_from_file_beginning>)  
--> <IVal_offset_in_bytes_from_file_beginning_or_-1>
```

```
"file_seek_cur"  
(file_seek_cur <IVal_file_descriptor>  
  <IVal_offset_in_bytes_from_file_current_offset>)  
--> <IVal_offset_in_bytes_from_file_beginning_or_-1>
```

```
"file_seek_end"  
(file_seek_end <IVal_file_descriptor>  
  <IVal_offset_in_bytes_from_file_end>)  
--> <IVal_offset_in_bytes_from_file_beginning_or_-1>
```

```
"file_close"  
(file_close <IVal_file_descriptor>)  
--> <IVal_0_or_-1>
```

```
"file_remove"  
(file_remove <SVal_file_name>)  
--> <IVal_0_or_-1>
```

```
"user_io"  
(user_io <IVal_user_defined_integer> <IVal_user_defined_string>)  
--> <SVal_string_returned_by_user_defined_io_c_function>
```

A.6 Built-in comparison functions

Second argument type will be casted to first argument type:

```
"==" "equal"  
(== <Val_value1> <Val_value2>)  
--> <IVal_true_if_value1_and_value2_are_equal_otherwise_false>
```

```
"!=" "notequal"  
(!= <Val_value1> <Val_value2>)  
--> <IVal_true_if_value1_and_value2_are_not_equal_otherwise_false>
```

```
"<" "less"  
(< <Val_value1> <Val_value2>)  
--> <IVal_true_if_value1_is_less_than_value2_otherwise_false>
```

```
">" "greater"  
(> <Val_value1> <Val_value2>)  
--> <IVal_true_if_value1_is_greater_than_value2_otherwise_false>
```

```
"<=" "lessequal"  
(<= <Val_value1> <Val_value2>)  
--> <IVal_true_if_value1_is_less_than_value2_or_  
_if_value1_and_value2_are_equal_otherwise_false>
```

```
">=" "greaterorequal"  
(>= <Val_value1> <Val_value2>)  
--> <IVal_true_if_value1_is_greater_than_value2_or_  
_if_value1_and_value2_are_equal_otherwise_false>
```

A.7 Built-in boolean functions

Argument types will be casted:

```
"&&" "and"  
(&& <IVal_boolean1> <IVal_boolean2_short_circuit_evaluation>)  
--> <IVal_boolean_AND>
```

```
"||" "or"  
(|| <IVal_boolean1> <IVal_boolean2_short_circuit_evaluation>)  
--> <IVal_boolean_OR>
```

```
!" "not"  
(! <IVal_boolean>)  
--> <IVal_boolean_NOT>
```

A.8 Built-in integer functions

Argument types will be casted:

<pre>"ival" (ival <Val_value> --> <IVal_integer></pre>
<pre>"indices" (indices <Val_value> --> <IVal_number_of_array_indices></pre>
<pre>"irnd" (irnd <IVal_maxrange_or_negative_to_reset_random_generator> --> <IVal_random_value_within_the_range_of_0_to_maxrange></pre>
<pre>"+" "iadd" (+ <IVal_integer1> <IVal_integer2> --> <IVal_addition_integer1+integer2></pre>
<pre>"-" "isub" (- <IVal_integer1> <IVal_integer2> --> <IVal_subtraction_integer1-integer2></pre>
<pre>"*" "imul" (* <IVal_integer1> <IVal_integer2> --> <IVal_multiplication_integer1*integer2></pre>
<pre>"/" "idiv" (/ <IVal_integer1> <IVal_integer2> --> <IVal_division_integer1/integer2></pre>
<pre>"*+" "ima" (*+ <IVal_integer1> <IVal_integer2> <IVal_integer3> --> <IVal_MultiplyAccumulateOperation_integer1*integer2+integer3></pre>

```
"%" "imod"  
(% <IVal_integer1> <IVal_integer2>)  
--> <IVal_modulo_integer_remainder_integer1%integer2>
```

```
"++" "iincr"  
(++ <IVal_integer>)  
--> <IVal_increment>
```

```
"--" "idecr"  
(-- <IVal_integer>)  
--> <IVal_decrement>
```

```
"0-" "ineg"  
(0- <IVal_integer>)  
--> <IVal_additive_inverse>
```

```
"iabs"  
(iabs <IVal_integer>)  
--> <IVal_absolute_value>
```

```
"&" "iand"  
(& <IVal_integer1> <IVal_integer2>)  
--> <IVal_bitwise_AND>
```

```
"|" "ior"  
(| <IVal_integer1> <IVal_integer2>)  
--> <IVal_bitwise_OR>
```

```
"^" "ixor"  
(^ <IVal_integer1> <IVal_integer2>)  
--> <IVal_bitwise_exclusive_OR>
```

```
"~" "inot"  
(~ <IVal_integer>)  
--> <IVal_bitwise_inversion>
```



```
">>" "ishr"  
(>> <IVal_integer> <IVal_shift_positions>)  
--> <IVal_bitwise_right_shift>
```

```
"<<" "ishl"  
(<< <IVal_integer> <IVal_shift_positions>)  
--> <IVal_bitwise_left_shift>
```

A.9 Built-in float functions

Argument types will be casted:

```
"fval"  
(fval <Val_value>)  
--> <FVal_float>
```

```
"frnd"  
(frnd <FVal_maxrange_or_negative_to_reset_random_generator>)  
--> <FVal_random_value_within_the_range_of_0_to_maxrange>
```

```
"+" "fadd"  
(+. <FVal_float1> <FVal_float2>)  
--> <FVal_addition_float1+float2>
```

```
"-." "fsub"  
(-. <FVal_float1> <FVal_float2>)  
--> <FVal_subtraction_float1-float2>
```

```
"*." "fmul"  
(* <FVal_float1> <FVal_float2>)  
--> <FVal_multiplication_float1*float2>
```

```
"/." "fdiv"  
(/. <FVal_float1> <FVal_float2>)  
--> <FVal_division_float1/float2>
```

```
"*+." "fma"  
(*+. <FVal_float1> <FVal_float2> <FVal_float3>)  
--> <FVal_MultiplyAccumulateOperation_float*float2+float3>
```

```
"fabs"  
(fabs <FVal_float>)  
--> <FVal_absolute_value>
```

```
"fint" "int"  
(fint <FVal_float>  
  --> <FVal_integer_part>
```

```
"fround" "round"  
(fround <FVal_float>  
  --> <FVal_rounded_value>
```

```
"fcos" "cos"  
(fcos <FVal_radians>  
  --> <FVal_cosine>
```

```
"fsin" "sin"  
(fsin <FVal_radians>  
  --> <FVal_sine>
```

```
"fcas" "cas"  
(fcas <FVal_radians>  
  --> <FVal_sine+cosine>
```

```
"fatn" "atn"  
(fatn <FVal_float>  
  --> <FVal_arctangent_radians>
```

```
"fexp" "exp"  
(fexp <FVal_float>  
  --> <FVal_exponential>
```

```
"fpow" "pow" "^." "***"  
(fpow <FVal_base> <FVal_exponent>  
  --> <FVal_base_raised_to_the_power_of_exponent>
```

```
"fln" "ln"  
(fln <FVal_float>  
  --> <FVal_natural_logarithm_base_E>
```

```
"fsqrt" "sqrt" "sqr"  
(fsqrt <FVal_float>  
  --> <FVal_square_root>
```

A.10 Built-in string functions

Argument types will be casted:

```
"str"  
  (str <Val_value>)  
  --> <SVal_string>
```

```
"chr"  
  (chr <IVal_integer>)  
  --> <SVal_one_character_string>
```

```
"asc"  
  (asc <SVal_string>)  
  --> <IVal_code_of_first_character>
```

```
"type"  
  (type <Val_value>)  
  --> <SVal_type_among_I_F_S_Z>
```

```
"dump_i2s"  
  (dump_i2s <IVal_integer>)  
  --> <SVal_memory_dump_of_integer>
```

```
"dump_f2s"  
  (dump_f2s <FVal_float>)  
  --> <SVal_memory_dump_of_float>
```

```
"dump_s2i"  
  (dump_s2i <SVal_string>)  
  --> <IVal_integer_dumped_from_string>
```

```
"dump_s2f"  
  (dump_s2f <SVal_string>)  
  --> <FVal_float_dumped_from_string>
```

```
"notEmpty"  
(notEmpty <SVal_string>  
  --> <IVal_true_if_not_empty>
```

```
"len"  
(len <SVal_string>  
  --> <IVal_length>
```

```
"at"  
(at <SVal_substring_to_be_found> <SVal_string_to_be_searched_in>  
  --> <IVal_found_first_occurrence_position_from_left_or_zero>
```

```
"rat"  
(rat <SVal_substring_to_be_found> <SVal_string_to_be_searched_in>  
  --> <IVal_found_first_occurrence_position_from_right_or_zero>
```

```
"cat"  
(cat <SVal_string1> <SVal_string2>  
  --> <SVal_concatenation_string1+string2>
```

```
"space"  
(space <IVal_length>  
  --> <SVal_empty_string_filled_with_spaces>
```

```
"replicate"  
(replicate <SVal_pattern> <IVal_number_of_copies>  
  --> <SVal_string_filled_with_patterns>
```

```
"left"  
(left <SVal_string> <IVal_position_from_left>  
  --> <SVal_left_part_of_string>
```

```
"leftr"  
(leftr <SVal_string> <IVal_position_from_right>  
  --> <SVal_left_part_of_string>
```

```
"right"  
(right <SVal_string> <IVal_position_from_right>)  
--> <SVal_right_part_of_string>
```

```
"rightl"  
(rightl <SVal_string> <IVal_position_from_left>)  
--> <SVal_right_part_of_string>
```

```
"substr"  
(substr <SVal_string> <IVal_position_from_left> <IVal_length>)  
--> <SVal_substring_derived_from_string>
```

```
"strtran"  
(strtran <SVal_string> <SVal_pattern> <SVal_substitution>)  
--> <SVal_string_where_patterns_are_replaced_with_substitutions>
```

```
"str_raw"  
(str_raw <SVal_string>)  
--> <SVal_string_with_no_escape_characters_for_special_symbols>
```

```
"str_unraw"  
(str_unraw <SVal_string>)  
--> <SVal_string_with_escape_characters_for_special_symbols>
```

```
"str_dump"  
(str_dump <SVal_string>)  
--> <SVal_semihexadecimal_string_dump>
```

```
"str_fmt"  
(str_fmt <SVal_printf_format> <Val_value>)  
--> <SVal_printf_formatted_string>
```

```
"ltrim"  
(ltrim <SVal_string>)  
--> <SVal_string_with_no_leading_blanks>
```

```
"rtrim"  
(rtrim <SVal_string>  
  --> <SVal_string_with_no_ending_blanks>
```

```
"alltrim"  
(alltrim <SVal_string>  
  --> <SVal_string_with_neither_leading_nor_ending_blanks>
```

```
"pack"  
(pack <SVal_string>  
  --> <SVal_string_with_no_redundant_blanks>
```

```
"head"  
(head <SVal_string>  
  --> <SVal_first_token>
```

```
"tail"  
(tail <SVal_string>  
  --> <SVal_remaining_tokens>
```

```
"lsp_head"  
(lsp_head <SVal_string>  
  --> <SVal_first_FastLisp_token>
```

```
"lsp_tail"  
(lsp_tail <SVal_string>  
  --> <SVal_remaining_FastLisp_tokens>
```

```
"upper"  
(upper <SVal_string>  
  --> <SVal_upper_case_string>
```

```
"lower"  
(lower <SVal_string>  
  --> <SVal_lower_case_string>
```



```
"rev"  
(rev <SVal_string>  
  --> <SVal_reverse_ordered_string>
```

```
"padl"  
(padl <SVal_string> <IVal_length>  
  --> <SVal_left_justified_string>
```

```
"padr"  
(padr <SVal_string> <IVal_length>  
  --> <SVal_right_justified_string>
```

```
"padc"  
(padc <SVal_string> <IVal_length>  
  --> <SVal_centered_string>
```

```
"time"  
(time)  
  --> <SVal_current_system_time>
```

```
"getenv"  
(getenv <SVal_environment_variable_name>  
  --> <SVal_environment_variable_value>
```

A.11 Built-in asynchronous memory heap functions

Argument types will be casted:

```
"asyncheap_create"  
(asyncheap_create <IVal_size_bytes>  
--> <IVal_descriptor_or_0>
```

```
"asyncheap_getaddress"  
(asyncheap_getaddress <IVal_descriptor>  
--> <IVal_address>
```

```
"asyncheap_putint"  
(asyncheap_putint <IVal_descriptor> <IVal_offset> <IVal_integer>  
--> <IVal_1>
```

```
"asyncheap_getint"  
(asyncheap_getint <IVal_descriptor> <IVal_offset>  
--> <IVal_integer>
```

```
"asyncheap_putfloat"  
(asyncheap_putfloat <IVal_descriptor> <IVal_offset> <FVal_float>  
--> <IVal_1>
```

```
"asyncheap_getfloat"  
(asyncheap_getfloat <IVal_descriptor> <IVal_offset>  
--> <FVal_float>
```

```
"asyncheap_putstring"  
(asyncheap_putstring <IVal_descriptor> <IVal_offset> <SVal_string>  
--> <IVal_1>
```

```
"asyncheap_getstring"  
(asyncheap_getstring <IVal_descriptor> <IVal_offset> <IVal_length>  
--> <SVal_string>
```

```
"asyncheap_reallocate"  
(asyncheap_reallocate <IVal_descriptor> <IVal_new_size_bytes>)  
--> <IVal_new_descriptor>
```

```
"asyncheap_replicate"  
(asyncheap_replicate <IVal_descriptor>)  
--> <IVal_new_descriptor>
```

```
"asyncheap_delete"  
(asyncheap_delete <IVal_descriptor>)  
--> <IVal_1>
```

A.12 Built-in mapcar function

Argument types will be casted:

```
"mapcar"  
(mapcar <SVal_FastLisp_function_or_compiled_bytecode>  
  --> (<SVal_preprinted_info>  
    <Val_result_of_execution_that_can_be_list_or_tree_as_well>  
    <IVal_syntax_error_code>  
    <SVal_syntax_error_message>  
    <IVal_runtime_error_code>  
    <SVal_runtime_error_message>  
    <SVal_processed_FastLisp_function_code>  
    <SVal_processed_FastLisp_function_compiled_bytecode>  
    <SVal_processed_FastLisp_function_linked_bytecode>  
    <FVal_time_spent_seconds>  
  )
```

A.13 Built-in terminal capabilities functions

Argument types will be casted:

```
"reinit_terminal"  
(reinit_terminal <SVal_terminal_type_or_empty_for_default_terminal>  
--> <SVal_terminal_capabilities_status>
```

```
"term_type"  
(term_type)  
--> <SVal_TERM_environment_configured_terminal_name>
```

```
"lines_term"  
(lines_term)  
--> <IVal_terminal_capability_li>
```

```
"columns_term"  
(columns_term)  
--> <IVal_terminal_capability_co>
```

```
"clrscr_term"  
(clrscr_term)  
--> <SVal_terminal_capability_cl>
```

```
"reverse_term"  
(reverse_term)  
--> <SVal_terminal_capability_mr>
```

```
"blink_term"  
(blink_term)  
--> <SVal_terminal_capability_mb>
```

```
"bold_term"  
(bold_term)  
--> <SVal_terminal_capability_md>
```

```
"normal_term"  
(normal_term)  
--> <SVal_terminal_capability_me>
```

```
"hidecursor_term"  
(hidecursor_term)  
--> <SVal_terminal_capability_vi>
```

```
"showcursor_term"  
(showcursor_term)  
--> <SVal_terminal_capability_ve>
```

```
"gotocursor_term"  
(gotocursor_term <IVal_y_coordinate> <IVal_x_coordinate>)  
--> <SVal_filled_with_coordinates_terminal_capability_cm_  
_or_unfilled_terminal_capability_cm_if_input_is_negative>
```

```
"gotocursor1_term"  
(gotocursor1_term <SVal_unfilled_terminal_capability_cm>  
 <IVal_y_coordinate> <IVal_x_coordinate>)  
--> <SVal_filled_with_coordinates_terminal_capability_cm>
```

A.14 Built-in constant and info functions

<pre>"ee" (ee) --> <FVal_base_of_natural_logarithm_e></pre>
<pre>"gamma" (gamma) --> <FVal_Euler_Mascheroni_constant_gamma></pre>
<pre>"phi" (phi) --> <FVal_golden_ratio_constant_phi></pre>
<pre>"pi" (pi) --> <FVal_constant_pi></pre>
<pre>"prn_integer_fmt" (prn_integer_fmt) --> <SVal_preconfigured_printf_format_for_integer></pre>
<pre>"prn_float_fmt" (prn_float_fmt) --> <SVal_preconfigured_printf_format_for_float></pre>
<pre>"prn_string_fmt" (prn_string_fmt) --> <SVal_preconfigured_printf_format_for_string></pre>
<pre>"version_fstlisp" (version_fstlisp) --> <SVal_FastLisp_version></pre>

```
"version_termcap"  
(version_termcap)  
--> <SVal_termcap_library_version>
```

```
"version_strglib"  
(version_strglib)  
--> <SVal_string_library_version>
```

```
"version_mempool"  
(version_mempool)  
--> <SVal_memory_pool_library_version>
```

```
"compiled_on"  
(compiled_on)  
--> <SVal_compilation_related_machine_os_kernel_specific_info>
```

```
"compiled_by"  
(compiled_by)  
--> <SVal_compilation_related_machine_compiler_specific_info>
```

```
"n_cpuproc"  
(n_cpuproc)  
--> <IVal_number_of_configured_parallel_processing_units>
```

```
"id_cpuproc"  
(id_cpuproc)  
--> <IVal_id_of_current_parallel_processing_unit>
```

```
"n_taskjob"  
(n_taskjob)  
--> <IVal_number_of_maximal_parallel_task_jobs>
```

```
"id_taskjob"  
(id_taskjob)  
--> <IVal_id_of_current_task_job>
```



```
"am_I_in_the_fastlisp_module"  
(am_I_in_the_fastlisp_module)  
--> <IVal_true_if_running_in_the_fastlisp_module>
```

```
"am_I_in_the_BMDFMldr_module"  
(am_I_in_the_BMDFMldr_module)  
--> <IVal_true_if_running_in_the_BMDFMldr_module>
```

```
"am_I_in_the_BMDFMsrv_module"  
(am_I_in_the_BMDFMsrv_module)  
--> <IVal_true_if_running_in_the_BMDFMsrv_module>
```

```
"am_I_in_the_CPUPROC_module"  
(am_I_in_the_CPUPROC_module)  
--> <IVal_true_if_running_in_the_CPUPROC_module>
```

```
"am_I_in_the_multithreaded_module"  
(am_I_in_the_multithreaded_module)  
--> <IVal_true_if_running_in_the_multithreaded_module>
```

A.15 Built-in rise runtime error functions

Argument types will be casted:

```
"rise_error"  
(rise_error)
```

```
"rise_error_info"  
(rise_error_info <IVal_error_code> <SVal_error_text>)
```

A.16 C Interface

See `cflp_udf.h/cflp_udf.c` for details.

In order to simplify declaration constructions the following abbreviations are used for the standard types:

```
#define CHR char
#define UCH unsigned char
#define SCH signed char
#define USH unsigned short int
#define SSH signed short int
#define ULO unsigned long int
#define SLO signed long int
#define DFL double
```

Each variable is stored in a universal structure that enables it to change data types dynamically and to have a single value or an array with different types of members, thus supporting lists and trees.

The declaration of a variable of the universal structure type allocates a single value on the stack and an array in the heap that is very convenient assuming most variables store only single values. No memory overhead is needed for storing arrays with members of the same type.

```

struct fastlisp_data{
    UCH disable_ptr; /* 1 stores value, 0 ptr to a variable possible */
    UCH single;      /* 1 single value, 0 array */
    UCH type;        /* 0 undef, 'I'int, 'F'float, 'S'string, 'Z'nil */
    UCH arraytype;   /* 0 undef, 'I'int, 'F'float, 'S'string, 'Z'nil */
    union{
        SLO ival;    /* integer value */
        DFL fval;    /* float value */
    } value;
    CHR *svalue;     /* string value */
    ULO indices_numb; /* number of indices in the array */
    UCH *aready_tags; /* member flags 'OIFSZ' for arraytype!=0 */
    union{
        struct fastlisp_data *mix; /* array members of mixed types */
        SLO *ival;                 /* array members of integer type */
        DFL *fval;                 /* array members of float type */
        CHR **svalue;              /* array members of string type */
    } array;
};

```

A user C function can be defined through the following type declaration:

```

typedef void (*fcall)(const ULO*, struct fastlisp_data*);

```

The first argument is a pointer to the passed function arguments and the second argument is a pointer to the result structure.

Passed arguments can be obtained from inside the function via the following set:

```

/* get universal data structure (see ret_val implementation below) */
void (*fcall)(const ULO*, struct fastlisp_data*);

/* get integer or pointer value */
void ret_ival(const ULO *dat_ptr, SLO *targ);

/* get float value */
void ret_fval(const ULO *dat_ptr, DFL *targ);

/* get string value */
void ret_sval(const ULO *dat_ptr, CHR **targ);

```

Additionally, there are:

- two helper functions to be called from each created user thread;
- two functions for copying and deleting the universal data structure;
- three callback functions;
- four info functions for the processing units and task jobs;
- five info functions for the modules;
- five functions to handle runtime errors.

```

/* helper functions to be called from each created user thread
   (if this thread uses BMDFM functionality) */

void setup_bmdfm_thread_safe_functionality_for_local_thread(void);

void cleanup_bmdfm_thread_safe_functionality_for_local_thread(void);

```

```

/* copy the universal data structure */
void copy_flp_data(struct fastlisp_data *dest,
                  const struct fastlisp_data *source,
                  ULO indices_numb);

/* delete the universal data structure */
void free_flp_data(struct fastlisp_data *ret_dat);

```

```
/* called at startup */
void startup_callback(void);

/* called at task job end */
void taskjob_end_callback(ULO id_taskjob);

/* (user_io <IVal> <SVal>) callee */
void user_io_callback(SLO usr_id, CHR **usr_buff);
```

```
/* get the number of configured parallel processing units
('N_CPUPROC' configuration parameter) */
ULO get_n_cpuproc(void);

/* get ID of the current parallel processing unit
(within the range of [0; 'N_CPUPROC'[]) */
ULO get_id_cpuproc(void);

/* get the number of maximal parallel task jobs
('N_IORBP' configuration parameter) */
ULO get_n_taskjob(void);

/* get ID of the current task job
(within the range of [0; 'N_IORBP'[]) */
ULO get_id_taskjob(void);
```

```
/* info functions for the modules */

UCH am_I_in_the_fastlisp_module(void);

UCH am_I_in_the_BMDFMldr_module(void);

UCH am_I_in_the_BMDFMsrv_module(void);

UCH am_I_in_the_CPUPROC_module(void);

UCH am_I_in_the_multithreaded_module(void);
```

```
/* check whether no runtime error occurred */
UCH noterror(void);

/* rise runtime error */
void rise_error(void);

/* rise runtime error info */
void rise_error_info(UCH errcode, const CHR *errtext);

/* get runtime error code */
UCH get_error_code(void);

/* get runtime error text */
CHR *get_error_text(CHR **errtext);

/* Reserved runtime error codes:
ECODE_RT__INT_DIVZERO          1
ECODE_RT__INT_MODZERO         2
ECODE_RT__FLOAT_DIVZERO      3
ECODE_RT__FLOAT_POWER        4
ECODE_RT__FLOAT_LOGARITHM    5
ECODE_RT__FLOAT_SQRT         6
ECODE_RT__AHEAP_WRONGDESCR   7
ECODE_RT__AHEAP_OUTOFRANGE   8
ECODE_RT__WRONG_FMT_STRING   9
ECODE_RT__VAR_NOTINIT       10
ECODE_RT__ARR_NOTINIT       11
ECODE_RT__ARR_MEMBSNOTINIT  12
ECODE_RT__ARR_NEGINDEX     13
ECODE_RT__ARR_ZEROMEMB     14
ECODE_RT__ARR_WRONGINDICES  15
ECODE_RT__ARR_TYPEMISMATCH  16
ECODE_RT__RESERVED6        249
ECODE_RT__RESERVED5        250
ECODE_RT__RESERVED4        251
ECODE_RT__RESERVED3        252
ECODE_RT__RESERVED2        253
ECODE_RT__RESERVED1        254
ECODE_RT__RESERVED0        255
*/
```

The final step, which should be performed after a user C function is defined, is to fill the instruction database according to the following structure:

```
typedef struct{
    const CHR *fnc_name; /* function name */
    const SSH operands; /* number of arguments */
    const UCH ret_type; /* result type: 'I', 'F', 'S', 'Z' */
    const UCH *op_type; /* flags 'IFSZ' for every argument */
    const fcall func_ptr; /* pointer to the function */
} INSTRUCTION_STRU;
```

See an example of a user defined C function below. Passed function arguments are obtained sequentially through the incremented "dat_ptr". Internal calls to "ret_ival", "ret_fval" and "ret_sval" provide dynamic type casting if required. A direct "fcall" function invocation omits the dynamic casting and returns a universal data structure.

Finally, "my_function" is registered in the instruction database. The corresponding record states that the function has five arguments and returns an integer value. Argument types are integer, integer, float, string and integer respectively.

```
"my_function"
(my_function <IVal> <IVal> <FVal> <SVal> <IVal>)
--> <IVal>
```

```
void my_function(const ULO *dat_ptr, struct fastlisp_data *ret_dat){
    const ULO *tmp_ptr;
    SLO n,result=0;
    CHR *str=NULL;
    DFL *f_array,koef;
    struct fastlisp_data dat={0,1,0,0,{0},NULL,1,NULL,{NULL}};

    ret_ival(dat_ptr,&n); /* arg0: integer (n) */
    ret_ival(dat_ptr+1,(SLO*)&f_array); /* arg1: ptr (f_array) */
    ret_fval(dat_ptr+2,&koef); /* arg2: float (koef) */
    ret_sval(dat_ptr+3,&str); /* arg3: string (str) */
    tmp_ptr=((ULO**) (dat_ptr+4)); /* arg4: any data as */
    (*(fcall)*tmp_ptr)(tmp_ptr+1,&dat); /* univ. data (dat) */
```



```

if(noterror()){
    /* data processing to compute `result': */
    ret_dat->single=1;
    ret_dat->type='I';
    ret_dat->value.ival=result;

    /* or an error occurred: */
    rise_error_info(USER_DEFINED_UNRESERVED_ERRCODE,"ERROR_TEXT");
}

if(dat.disable_ptr)
    free_flp_data(&dat);
free_string(&str);

return;
}

/* Users may implement their own ret_val() like:

void ret_val(const ULO *dat_ptr, struct fastlisp_data *ret_dat){
    dat_ptr=((ULO**)dat_ptr);
    (*(fcall)*dat_ptr)(dat_ptr+1,ret_dat);
    return;
}

or like:

void ret_val(const ULO *dat_ptr, struct fastlisp_data *ret_dat){
    if(noterror()){
        dat_ptr=((ULO**)dat_ptr);
        (*(fcall)*dat_ptr)(dat_ptr+1,ret_dat);
    }
    return;
}

in order to simplify reading universal data args, e.g.:

    ret_val(dat_ptr+4,&dat);
*/

INSTRUCTION_STRU INSTRUCTION_SET[]={
    /* ... */
    {"MY_FUNCTION",5,'I',(UCH*)"IIFSI",&my_function},
    /* ... */
};
const ULO INSTRUCTIONS=
    sizeof(INSTRUCTION_SET)/sizeof(INSTRUCTION_STRU);

```

And last but not least is string processing. Internally, strings are stored in the following format:

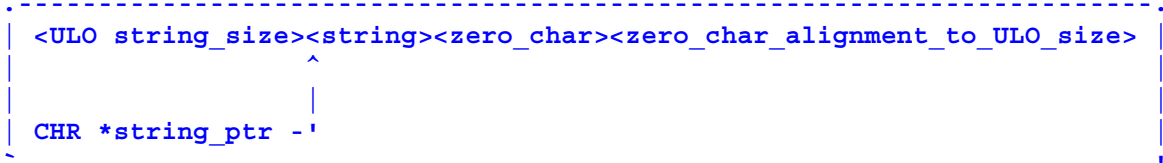

The implemented set of the string processing functions is basically equal to the same set on the FastLisp level:

```

CHR *mk_std_buff(CHR **buff, ULO size);
CHR *mk_std_buff_secure(CHR **buff, ULO size);
CHR *mk_fst_buff(CHR **buff, ULO size);
CHR *mk_fst_buff_secure(CHR **buff, ULO size);
CHR *get_std_buff(CHR **targ, const CHR *buff);
CHR *get_std_buff_secure(CHR **targ, const CHR *buff);
UCH notempty(const CHR *string);
ULO len(const CHR *string);
ULO at(const CHR *pattern, const CHR *among);
ULO rat(const CHR *pattern, const CHR *among);
UCH cmp(const CHR *string1, const CHR *string2);
SCH cmp_s(const CHR *string1, const CHR *string2);
CHR *equ(CHR **targ, const CHR *source);
CHR *equ_secure(CHR **targ, const CHR *source);
CHR *equ_num(CHR **targ, SLO num);
CHR *equ_fnum(CHR **targ, DFL fnum);
CHR *cat(CHR **targ, const CHR *source);
CHR *lcat(CHR **targ, const CHR *source);
CHR *space(CHR **targ, ULO pos);
CHR *replicate(CHR **targ, const CHR *source, ULO num);
CHR *left(CHR **targ, const CHR *source, ULO pos);
CHR *leftr(CHR **targ, const CHR *source, ULO posr);
CHR *right(CHR **targ, const CHR *source, ULO pos);
CHR *rightl(CHR **targ, const CHR *source, ULO posl);
CHR *substr(CHR **targ, const CHR *source, ULO from, ULO pos);
CHR *strtran(CHR **targ, const CHR *source, const CHR *pattern,
             const CHR *subst);
CHR *ltrim(CHR **targ, const CHR *source);
CHR *rtrim(CHR **targ, const CHR *source);
CHR *alltrim(CHR **targ, const CHR *source);
CHR *pack(CHR **targ, const CHR *source);
CHR *head(CHR **targ, const CHR *source);
CHR *tail(CHR **targ, const CHR *source);
CHR *lsp_head(CHR **targ, const CHR *source);
CHR *lsp_tail(CHR **targ, const CHR *source);
  
```

```

CHR *upper(CHR **targ, const CHR *source);
CHR *lower(CHR **targ, const CHR *source);
CHR *rev(CHR **targ, const CHR *source);
CHR *padl(CHR **targ, const CHR *source, ULO width);
CHR *padr(CHR **targ, const CHR *source, ULO width);
CHR *padc(CHR **targ, const CHR *source, ULO width);
CHR *strraw(CHR **targ, const CHR *source);
CHR *strunraw(CHR **targ, const CHR *source);
CHR *strdump(CHR **targ, const CHR *source);
CHR *string_time(CHR **targ);
CHR *strings_version(CHR **targ);
CHR *sch2str(CHR **targ, SCH num);
CHR *ssh2str(CHR **targ, SSH num);
CHR *slo2str(CHR **targ, SLO num);
CHR *ptr2str(CHR **targ, void *ptr);
CHR *df12str(CHR **targ, DFL num);
SCH str2sch(const CHR *string);
SSH str2ssh(const CHR *string);
SLO str2slo(const CHR *string);
void *str2ptr(const CHR *string);
DFL str2df1(const CHR *string);
CHR *free_string(CHR **targ);

```

An example of string processing is given below:

```

CHR *str0=NULL, *str1=NULL, *str2=NULL;
get_std_buff(&str0, "To be or not to be");
get_std_buff(&str1, "be");
get_std_buff(&str2, "compute");
upper(&str0, strtran(&str0, str0, str1, str2));
printf("%s\n", str0); /* Result: `TO COMPUTE OR NOT TO COMPUTE' */
free_string(&str0);
free_string(&str1);
free_string(&str2);

```

This page is intentionally left blank.

Appendix B

Example of Application Programming

This is a simple application example, which computes direct and inverse 2D nonseparative discrete Hartley transforms (DHT and IDHT) according to the computation flow shown in [Figure B-1](#).

$$H[p, q] = \sum_{n=0}^{N-1} \sum_{m=0}^{M-1} x[n, m] \cdot \text{cas} \left(\frac{2 \cdot \pi}{N} \cdot p \cdot n + \frac{2 \cdot \pi}{M} \cdot q \cdot m \right),$$

$p = 0..N-1, q = 0..M-1$

$$H_{inv}[p, q] = \frac{1}{N \cdot M} H[p, q]$$

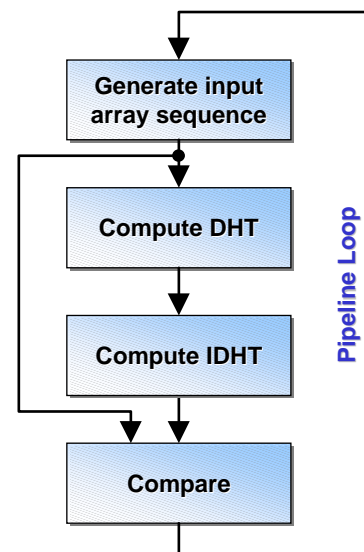

Figure B-1. Computation example of discrete Hartley transforms

Four functions from [Figure B-1](#) can be implemented in C as follows:

```

void func_dhtpipe0_generate(const ULO *dat_ptr, struct fastlisp_data *ret_dat){
    SLO i,j,n,m;
    DFL *array;
    ret_ival(dat_ptr, (SLO*)&array);
    ret_ival(dat_ptr+1, &n);
    ret_ival(dat_ptr+2, &m);
    if(noterror()){
        for(i=0; i<n; i++){
            for(j=0; j<m; j++){
                *(array+i*m+j)=1.*rand()/RAND_MAX;
            }
            ret_dat->single=1;
            ret_dat->type='I';
            ret_dat->value.ival= (SLO) array;
        }
    }
    return;
}

void func_dhtpipe0_dht(const ULO *dat_ptr, struct fastlisp_data *ret_dat){
    SLO i,j,p,q,n,m;
    DFL *target_array, *source_array, pi, c1, s1, sum, tmp;
    ret_ival(dat_ptr, (SLO*)&target_array);
    ret_ival(dat_ptr+1, &n);
    ret_ival(dat_ptr+2, &m);
    ret_ival(dat_ptr+3, (SLO*)&source_array);
    if(noterror()){
        pi=3.1415926535897932;
        c1=2*pi/n;
        s1=2*pi/m;
        for(p=0; p<n; p++){
            for(q=0; q<m; q++){
                sum=0;
                for(i=0; i<n; i++){
                    for(j=0; j<m; j++){
                        sum+= (*(source_array+i*m+j) * (cos(tmp=c1*p*i+s1*q*j)+sin(tmp)));
                    }
                    *(target_array+p*m+q)=sum;
                }
            }
            ret_dat->single=1;
            ret_dat->type='I';
            ret_dat->value.ival= (SLO) target_array;
        }
    }
    return;
}

```

Appendix B

```
void func__dhtpipe0_idht(const ULO *dat_ptr, struct fastlisp_data *ret_dat){
    SLO i,j,p,q,n,m;
    DFL *target_array,*source_array,pi,c1,s1,sum,tmp;
    ret_ival(dat_ptr,(SLO*)&target_array);
    ret_ival(dat_ptr+1,&n);
    ret_ival(dat_ptr+2,&m);
    ret_ival(dat_ptr+3,(SLO*)&source_array);
    if(noterror()){
        pi=3.1415926535897932;
        c1=2*pi/n;
        s1=2*pi/m;
        for(p=0;p<n;p++){
            for(q=0;q<m;q++){
                sum=0;
                for(i=0;i<n;i++){
                    for(j=0;j<m;j++){
                        sum+=*(source_array+i*m+j)*(cos(tmp=c1*p*i+s1*q*j)+sin(tmp));
                    }
                }
                *(target_array+p*m+q)=sum/n/m;
            }
        }
        ret_dat->single=1;
        ret_dat->type='I';
        ret_dat->value.ival=(SLO)target_array;
    }
    return;
}

void func__dhtpipe0_compare(const ULO *dat_ptr, struct fastlisp_data *ret_dat){
    SLO result=1,n,m;
    DFL *array0,*array1;
    ret_ival(dat_ptr,(SLO*)&array0);
    ret_ival(dat_ptr+1,(SLO*)&array1);
    ret_ival(dat_ptr+2,&n);
    ret_ival(dat_ptr+3,&m);
    if(noterror()){
        if((fabs(*array0-*array1)>1.e-10)
            || (fabs(*(array0+n*m-1)-*(array1+n*m-1))>1.e-10))
            result=0;
        ret_dat->single=1;
        ret_dat->type='I';
        ret_dat->value.ival=result;
    }
    return;
}

INSTRUCTION_STRU INSTRUCTION_SET[]={
    {"DHTPIPE0_GENERATE",3,'I',(UCH*)"IIII",&func__dhtpipe0_generate},
    {"DHTPIPE0_DHT",4,'I',(UCH*)"IIII",&func__dhtpipe0_dht},
    {"DHTPIPE0_IDHT",4,'I',(UCH*)"IIII",&func__dhtpipe0_idht},
    {"DHTPIPE0_COMPARE",4,'I',(UCH*)"IIII",&func__dhtpipe0_compare}
};
const ULO INSTRUCTIONS=sizeof(INSTRUCTION_SET)/sizeof(INSTRUCTION_STRU);
```

After recompilation of the virtual machine the following trivial implementation of the function `main()` will work properly. Please notice two things:

- Some speculative SMP RISC architectures require aligned memory addresses for allocated float arrays in the shared memory pool.
- Access to the asynchronous heaps can be synchronized e.g. via some additional synchronization helper variables that create artificial dataflow dependencies enabling parallel function calls where possible:
 - every pointer variable “*_addr*” has a corresponding synchronization helper variable “*_sync*”;
 - an “*_addr*” pointer variable to a read-only area can be passed directly to a function call;
 - an “*_addr*” pointer variable to a modified area is passed to a function call being dependent on the corresponding “*_sync*” helper variable;
 - after the function call is finished, both “*_sync*” helper variables (for all pointers involved in the call) and “*_addr*” pointer variables (only for pointers to the modified areas) are re-assigned.

```
# dhtpipe0.flp

# Pipeline calculation of the 2D nonseparative Hartley transform.
#
# Direct Hartley transform:
#
#           N-1  M-1           2Pi      2Pi
#   H[p,q] = E    E  x[n,m] cas ( --- pn + --- qm ), p=0..N-1, q=0..M-1.
#           n=0  m=0           N        M
#
# Inverse Hartley transform:
#
#           1
#   Hinv[p,q] = --- H[p,q].
#           N*M

(progn # main()

(outf
  "Pipeline calculation of the 2D nonseparative Hartley transform.\n\n" 0)
```



```

(setq m (ival (accept "M-value of M*N-matrix: ")))
(setq n (ival (accept "N-value of M*N-matrix: ")))
(setq numb (ival (accept "How many input data packs: ")))
(setq arrays_size (* (++ (* m n) (setq floatlen (len (dump_f2s 0.)))))

(for i 1 1 numb (progn # main pipeline loop

  (outf "Sequence %ld:" i)

  #####
  # 1. This is the way how we create an input array. #
  # 1.1. This is the way how we get address. #
  #####
  (setq inp_array_addr (setq inp_array_addr_
    (asyncheap_create arrays_size)))

  #####
  # 1.2. This is the way how we align the address. #
  # (optional: float might be misaligned on some architectures). #
  #####
  (setq inp_array_sync (& 0
    (setq inp_array_addr
      (+ inp_array_addr (- floatlen (iabs (% inp_array_addr floatlen))))))
  ))

  #####
  # 2. This is the way how we generate input sequence. #
  #####
  (setq inp_array_sync (& 0
    (setq inp_array_addr
      (dhtpipe0_generate (| inp_array_sync inp_array_addr) n m)
    ))
  ))

  #####
  # 3. This is the way how we create a DHT array. #
  # 3.1. This is the way how we get address. #
  #####
  (setq dht_array_addr (setq dht_array_addr_
    (asyncheap_create arrays_size)))

  #####
  # 3.2. This is the way how we align the address. #
  # (optional: float might be misaligned on some architectures). #
  #####
  (setq dht_array_sync (& 0
    (setq dht_array_addr
      (+ dht_array_addr (- floatlen (iabs (% dht_array_addr floatlen))))))
  ))

```

```

#####
# 4. This is the way how we compute DHT. #
#####
(setq dht_array_sync (setq inp_array_sync (& 0
  (setq dht_array_addr
    (dhtpipe0_dht (| dht_array_sync dht_array_addr) n m inp_array_addr))
)))

#####
# 5. This is the way how we create an IDHT array. #
# 5.1. This is the way how we get address. #
#####
(setq idht_array_addr (setq idht_array_addr_
  (asyncheap_create arrays_size)))

#####
# 5.2. This is the way how we align the address. #
# (optional: float might be misaligned on some architectures). #
#####
(setq idht_array_sync (& 0
  (setq idht_array_addr
    (+ idht_array_addr (- floatlen (iabs (% idht_array_addr floatlen))))))
)

#####
# 6. This is the way how we compute IDHT. #
#####
(setq idht_array_sync (setq dht_array_sync (& 0
  (setq idht_array_addr
    (dhtpipe0_idht (| idht_array_sync idht_array_addr) n m dht_array_addr))
)))

#####
# 7. This is the way how we compare input_sequence with #
# IDHT(DHT(input_sequence)). #
#####
(setq inp_array_sync (setq idht_array_sync (& 0
  (setq cmp_res (dhtpipe0_compare inp_array_addr idht_array_addr n m))
)))
(outf " %s.\n" (if cmp_res "Ok" "Fail"))

#####
# 8. This is the way how we release memory. #
#####
(asyncheap_delete (| inp_array_sync inp_array_addr_))
(asyncheap_delete (| dht_array_sync dht_array_addr_))
(asyncheap_delete (| idht_array_sync idht_array_addr_))

) # "end progn" of main pipeline loop; "end for" of main pipeline loop
""

) # "end progn" of main()

```

Appendix B

The above version of the application exploits a coarse-grain parallelism of the iterations of the main pipeline loop. In the next version of the same application the computation loops written in C are interleaved. This modification enables using a coarse-grain parallelism within each iteration of the main pipeline loop.

```
void func__dhtpipe1_generate(const ULO *dat_ptr, struct fastlisp_data *ret_dat){
    SLO step,interleave,i,j,n,m;
    DFL *array;
    ret_ival(dat_ptr,(SLO*)&array);
    ret_ival(dat_ptr+1,&step);
    ret_ival(dat_ptr+2,&interleave);
    ret_ival(dat_ptr+3,&n);
    ret_ival(dat_ptr+4,&m);
    if(noterror()){
        for(i=step;i<n;i+=interleave)
            for(j=0;j<m;j++)
                *(array+i*m+j)=1.*rand()/RAND_MAX;
        ret_dat->single=1;
        ret_dat->type='I';
        ret_dat->value.ival=0;
    }
    return;
}

void func__dhtpipe1_dht(const ULO *dat_ptr, struct fastlisp_data *ret_dat){
    SLO step,interleave,i,j,p,q,n,m;
    DFL *target_array,*source_array,pi,c1,s1,sum,tmp;
    ret_ival(dat_ptr,(SLO*)&target_array);
    ret_ival(dat_ptr+1,&step);
    ret_ival(dat_ptr+2,&interleave);
    ret_ival(dat_ptr+3,&n);
    ret_ival(dat_ptr+4,&m);
    ret_ival(dat_ptr+5,(SLO*)&source_array);
    if(noterror()){
        pi=3.1415926535897932;
        c1=2*pi/n;
        s1=2*pi/m;
        for(p=step;p<n;p+=interleave)
            for(q=0;q<m;q++){
                sum=0;
                for(i=0;i<n;i++)
                    for(j=0;j<m;j++)
                        sum+=(*(source_array+i*m+j))*(cos(tmp=c1*p*i+s1*q*j)+sin(tmp));
                *(target_array+p*m+q)=sum;
            }
        ret_dat->single=1;
        ret_dat->type='I';
        ret_dat->value.ival=0;
    }
    return;
}
```

```

void func_dhtpipe1_idht(const ULO *dat_ptr, struct fastlisp_data *ret_dat){
    SLO step,interleave,i,j,p,q,n,m;
    DFL *target_array,*source_array,pi,c1,s1,sum,tmp;
    ret_ival(dat_ptr,(SLO*)&target_array);
    ret_ival(dat_ptr+1,&step);
    ret_ival(dat_ptr+2,&interleave);
    ret_ival(dat_ptr+3,&n);
    ret_ival(dat_ptr+4,&m);
    ret_ival(dat_ptr+5,(SLO*)&source_array);
    if(noterror()){
        pi=3.1415926535897932;
        c1=2*pi/n;
        s1=2*pi/m;
        for(p=step;p<n;p+=interleave)
            for(q=0;q<m;q++){
                sum=0;
                for(i=0;i<n;i++)
                    for(j=0;j<m;j++){
                        sum+=(*(source_array+i*m+j)*(cos(tmp=c1*p*i+s1*q*j)+sin(tmp)));
                        *(target_array+p*m+q)=sum/n/m;
                    }
                ret_dat->single=1;
                ret_dat->type='I';
                ret_dat->value.ival=0;
            }
        return;
    }
}

INSTRUCTION_STRU INSTRUCTION_SET[]={
    // ...
    {"DHTPIPE1_GENERATE",5,'I',(UCH*)"IIIII",&func_dhtpipe1_generate},
    {"DHTPIPE1_DHT",6,'I',(UCH*)"IIIIII",&func_dhtpipe1_dht},
    {"DHTPIPE1_IDHT",6,'I',(UCH*)"IIIIII",&func_dhtpipe1_idht},
    // ...
};
const ULO INSTRUCTIONS=sizeof(INSTRUCTION_SET)/sizeof(INSTRUCTION_STRU);

```

In the function main() all interleaved functions are called in a way of the threaded loops:

```

# dhtpipe1.flp

# Pipeline calculation of the 2D nonseparative Hartley transform.
#
# Direct Hartley transform:
#
#           N-1  M-1           2Pi      2Pi
#   H[p,q] = E   E x[n,m] cas ( --- pn + --- qm ), p=0..N-1, q=0..M-1.
#           n=0  m=0           N        M
#
# Inverse Hartley transform:
#
#           1
#   Hinv[p,q] = --- H[p,q].
#           N*M

(progn # main()

  (outf
    "Pipeline calculation of the 2D nonseparative Hartley transform.\n\n" 0)
  (setq m (ival (accept "M-value of M*N-matrix: ")))
  (setq n (ival (accept "N-value of M*N-matrix: ")))
  (setq numb (ival (accept "How many input data packs: ")))
  (setq arrays_size (* (+ (* m n)) (setq floatlen (len (dump_f2s 0))))))
  (setq threads (if (< n (n_cpuproc)) n (n_cpuproc)))

  (for i 1 1 numb (progn # main pipeline loop

    (outf "Sequence %ld:" i)

    #####
    # 1. This is the way how we create an input array. #
    # 1.1. This is the way how we get address. #
    #####
    (setq inp_array_addr (setq inp_array_addr_
      (asyncheap_create arrays_size)))

    #####
    # 1.2. This is the way how we align the address. #
    # (optional: float might be misaligned on some architectures). #
    #####
    (setq inp_array_sync (& 0
      (setq inp_array_addr
        (+ inp_array_addr (- floatlen (iabs (% inp_array_addr floatlen))))))
    ))
  )

```

```

#####
# 2. This is the way how we generate input sequence. #
#####
(setq inp_array_addr (| inp_array_sync inp_array_addr))
(for thread 1 1 threads
  (setq inp_array_sync (+ inp_array_sync
    (dhtpipel_generate inp_array_addr (-- thread) threads n m)))
)
(setq inp_array_addr (| inp_array_sync inp_array_addr))

#####
# 3. This is the way how we create a DHT array. #
# 3.1. This is the way how we get address. #
#####
(setq dht_array_addr (setq dht_array_addr_
  (asyncheap_create arrays_size)))

#####
# 3.2. This is the way how we align the address. #
# (optional: float might be misaligned on some architectures). #
#####
(setq dht_array_sync (& 0
  (setq dht_array_addr
    (+ dht_array_addr (- floatlen (iabs (% dht_array_addr floatlen))))))
))

#####
# 4. This is the way how we compute DHT. #
#####
(setq dht_array_addr (| dht_array_sync dht_array_addr))
(for thread 1 1 threads
  (setq dht_array_sync (+ dht_array_sync
    (dhtpipel_dht dht_array_addr (-- thread) threads n m inp_array_addr)))
)
(setq inp_array_sync dht_array_sync)
(setq dht_array_addr (| dht_array_sync dht_array_addr))

#####
# 5. This is the way how we create an IDHT array. #
# 5.1. This is the way how we get address. #
#####
(setq idht_array_addr (setq idht_array_addr_
  (asyncheap_create arrays_size)))

```

Appendix B

```
#####
# 5.2. This is the way how we align the address. #
# (optional: float might be misaligned on some architectures). #
#####
(setq idht_array_sync (& 0
  (setq idht_array_addr
    (+ idht_array_addr (- floatlen (iabs (% idht_array_addr floatlen))))))
)

#####
# 6. This is the way how we compute IDHT. #
#####
(setq idht_array_addr (| idht_array_sync idht_array_addr))
(for thread 1 1 threads
  (setq idht_array_sync (+ idht_array_sync (dhtpipe1_idht
    idht_array_addr (-- thread) threads n m dht_array_addr)))
)
(setq dht_array_sync idht_array_sync)
(setq idht_array_addr (| idht_array_sync idht_array_addr))

#####
# 7. This is the way how we compare input_sequence with #
# IDHT(DHT(input_sequence)). #
#####
(setq inp_array_sync (setq idht_array_sync (& 0
  (setq cmp_res (dhtpipe0_compare inp_array_addr idht_array_addr n m)
  )))
(if cmp_res
  (outf " Ok.\n" nil)
  (outf " Fail.\n" nil)
)

#####
# 8. This is the way how we release memory. #
#####
(asyncheap_delete (| inp_array_sync inp_array_addr))
(asyncheap_delete (| dht_array_sync dht_array_addr))
(asyncheap_delete (| idht_array_sync idht_array_addr))

) # "end progn" of main pipeline loop; "end for" of main pipeline loop
""

) # "end progn" of main()
```

This page is intentionally left blank.

Appendix C

List of Target Deployments

The target deployments are listed for the following release of BMDFM:

- BMDFM v.5.9.9 R15 (Revision 2015), build 20180713.

Deployment	Build Details
x86_Windows_32	file fastlisp.exe: PE32 executable (console) Intel 80386, for MS Windows Compiled on: CYGWIN NT-6.1 WINDOWS7VM 20.1 (0.3/1/1) 1998-12-3 20:39:18 i686 Compiled by: gcc version egcs-2.91.57 19980901 (egcs-1.1 release) as [PE32 executable (console) Intel 80386, for MS Windows] at systime Fri Jul 13 13:01:16 CEST 2018
x86_Windows-Cygwin_32	file fastlisp.exe: PE32 executable (console) Intel 80386 (stripped to external PDB), for MS Windows Compiled on: CYGWIN NT-6.1-WOW WINDOWS7VM 2.10.0(0.325/5/3) 2018-02-02 15:21 i686 Cygwin Compiled by: gcc version 6.4.0 (GCC) as [PE32 executable (console) Intel 80386 (stripped to external PDB), for MS Windows] at systime Fri Jul 13 13:01:19 CEST 2018
x86_Windows-UWIN_32	file fastlisp.exe: PE32 executable (console) Intel 80386, for MS Windows Compiled on: UWIN-XP WINXPVM 3.1-5.1 2600 i1586 Compiled by: gcc version 2.95.2 19991024 (release) as [win32 386 executable] at systime Fri Jul 13 13:01:24 CEST 2018
x86_Windows-SFU-SUA_32	file fastlisp: PE32 executable (POSIX) Intel 80386 (stripped to external PDB), for MS Windows Compiled on: Interix WINDOWS7VM 6.1 10.0.7063.0 x86 Compiled by: gcc version 3.3 as [Windows NT PE format (EXE), dynamically linked executable Intel POSIX-CUI] at systime Fri Jul 13 13:01:36 CEST 2018

x86_Linux_32	<p>file fastlisp: ELF 32-bit LSB executable, Intel 80386, version 1 (SYSV), dynamically linked (uses shared libs), for GNU/Linux 2.6.32, stripped</p> <p>Compiled on: Linux RedHatELS72VM 3.10.0-514.26.2.el7.x86_64 #1 SMP Fri Jun 30 05:26:04 UTC 2017 x86_64</p> <p>Compiled by: gcc version 4.8.5 20150623 (Red Hat 4.8.5-11) (GCC) as [ELF 32-bit LSB executable, Intel 80386, version 1 (SYSV), dynamically linked (uses shared libs), for GNU/Linux 2.6.32, stripped] at systime Fri Jul 13 13:01:14 CEST 2018</p>
x86_Linux_32_clang	<p>file fastlisp: ELF 32-bit LSB executable, Intel 80386, version 1 (SYSV), dynamically linked (uses shared libs), for GNU/Linux 2.6.32, stripped</p> <p>Compiled on: Linux RedHatELS72VM 3.10.0-514.26.2.el7.x86_64 #1 SMP Fri Jun 30 05:26:04 UTC 2017 x86_64</p> <p>Compiled by: clang version 3.8.1 (tags/RELEASE_381/final) as [ELF 32-bit LSB executable, Intel 80386, version 1 (SYSV), dynamically linked (uses shared libs), for GNU/Linux 2.6.32, stripped] at systime Fri Jul 13 13:05:07 CEST 2018</p>
x86_Linux_32_icc	<p>file fastlisp: ELF 32-bit LSB executable, Intel 80386, version 1 (SYSV), dynamically linked (uses shared libs), for GNU/Linux 2.6.18, stripped</p> <p>Compiled on: Linux RedHatELS62VM 2.6.32-220.13.1.el6.x86_64 #1 SMP Thu Mar 29 11:46:40 EDT 2012 x86_64</p> <p>Compiled by: icc Intel(R) C Intel(R) 64 Compiler XE for applications running on Intel(R) 64, Version 15.0.0.090 Build 20140723 (Copyright (C) 1985-2014 Intel Corporation. All rights reserved.) as [ELF 32-bit LSB executable, Intel 80386, version 1 (SYSV), dynamically linked (uses shared libs), for GNU/Linux 2.6.18, stripped] at systime Fri Jul 13 13:02:45 CEST 2018</p>
x86_FreeBSD_32	<p>file fastlisp: ELF 32-bit LSB executable, Intel 80386, version 1 (FreeBSD), dynamically linked (uses shared libs), for FreeBSD 11.0 (1100122), stripped</p> <p>Compiled on: FreeBSD FreeBSD11VM 11.0-RELEASE-p1 FreeBSD 11.0-RELEASE-p1 #0 r306420: Thu Sep 29 01:43:23 UTC 2016 root@releng2.nyi.freebsd.org:/usr/obj/usr/src/sys/GENERIC amd64</p> <p>Compiled by: gcc version 4.8.5 (FreeBSD Ports Collection) as [ELF 32-bit LSB executable, Intel 80386, version 1 (FreeBSD), dynamically linked (uses shared libs), for FreeBSD 11.0 (1100122), FreeBSD-style, stripped] at systime Fri Jul 13 13:01:20 CEST 2018</p>
x86_FreeBSD_32_clang	<p>file fastlisp: ELF 32-bit LSB executable, Intel 80386, version 1 (FreeBSD), dynamically linked (uses shared libs), for FreeBSD 11.0 (1100122), stripped</p> <p>Compiled on: FreeBSD FreeBSD11VM 11.0-RELEASE-p1 FreeBSD 11.0-RELEASE-p1 #0 r306420: Thu Sep 29 01:43:23 UTC 2016 root@releng2.nyi.freebsd.org:/usr/obj/usr/src/sys/GENERIC amd64</p> <p>Compiled by: FreeBSD clang version 3.8.0 (tags/RELEASE_380/final 262564) (based on LLVM 3.8.0) as [ELF 32-bit LSB executable, Intel 80386, version 1 (FreeBSD), dynamically linked (uses shared libs), for FreeBSD 11.0 (1100122), FreeBSD-style, stripped] at systime Fri Jul 13 13:06:12 CEST 2018</p>

Appendix C

x86_OpenBSD_32	<p>file fastlisp: ELF 32-bit LSB executable, Intel 80386, version 1 (SYSV), dynamically linked (uses shared libs), for OpenBSD, stripped</p> <p>Compiled on: OpenBSD OpenBSD32VM.ESXsrv.net 5.4 GENERIC#37 i386</p> <p>Compiled by: gcc version 4.2.1 20070719 (OpenBSD/i386 system compiler) as [ELF 32-bit LSB executable, Intel 80386, version 1, for OpenBSD, dynamically linked (uses shared libs), stripped] at systime Fri Jul 13 13:01:15 CEST 2018</p>
x86_NetBSD_32	<p>file fastlisp: ELF 32-bit LSB executable, Intel 80386, version 1 (SYSV), dynamically linked (uses shared libs), for NetBSD 6.1.2, stripped</p> <p>Compiled on: NetBSD NetBSD64VM.ESXsrv.net 6.1.2 NetBSD 6.1.2 (GENERIC) amd64</p> <p>Compiled by: gcc version 4.5.3 (NetBSD nb2 20110806) as [ELF 32-bit LSB executable, Intel 80386, version 1 (SYSV), dynamically linked (uses shared libs), for NetBSD 6.1.2, stripped] at systime Fri Jul 13 13:01:22 CEST 2018</p>
x86_MacOS_32	<p>file fastlisp: Mach-O i386 executable</p> <p>Compiled on: Darwin MacIntel 14.5.0 Darwin Kernel Version 14.5.0: Tue Apr 11 16:12:42 PDT 2017; root:xnu-2782.50.9.2.3-1/RELEASE_ARM_T8040 i386_64</p> <p>Compiled by: Apple LLVM version 7.0.2 (clang-700.1.81) as [Mach-O executable i386] at systime Fri Jul 13 13:01:23 CEST 2018</p>
x86_SunOS_32	<p>file fastlisp: ELF 32-bit LSB executable, Intel 80386, version 1, dynamically linked (uses shared libs), stripped, uses FPU</p> <p>Compiled on: SunOS SunOSi386VM 5.10 Generic_150401-46 i86pc i386</p> <p>Compiled by: cc: Sun C 5.10 SunOS i386 Patch 1423 63-09 2012/08/15 as [ELF 32-bit LSB executable 80386 Version 1 [FPU], dynamically linked, stripped] at systime Fri Jul 13 13:01:27 CEST 2018</p>
x86_SunOS_32_gcc	<p>file fastlisp: ELF 32-bit LSB executable, Intel 80386, version 1, dynamically linked (uses shared libs), stripped</p> <p>Compiled on: SunOS SunOSi386VM 5.10 Generic_150401-46 i86pc i386</p> <p>Compiled by: gcc version 3.4.3 (csl-sol210-3 4-branch+sol rpath) as [ELF 32-bit LSB executable 80386 Version 1, dynamically linked, stripped] at systime Fri Jul 13 13:15:04 CEST 2018</p>
x86_UnixWare_32	<p>file fastlisp: ELF 32-bit LSB executable, Intel 80386, version 1 (SYSV), dynamically linked (uses shared libs), stripped</p> <p>Compiled on: UnixWare unixware 5 7.1.4 i386 x86at SCO UNIX_SVR5</p> <p>Compiled by: Optimizing C Compilation System (CCS) 4.2 05/13/08 (uw714mp4.bl3h) as [ELF 32-bit LSB executable 80386, dynamically linked, stripped, no debug (SVR5 ABI)] at systime Fri Jul 13 13:01:40 CEST 2018</p>

x86_UnixWare_32_gcc	<p>file fastlisp: ELF 32-bit LSB executable, Intel 80386, version 1 (SYSV), dynamically linked (uses shared libs), stripped</p> <p>Compiled on: UnixWare unixware 5 7.1.4 i386 x86at SCO UNIX SVR5</p> <p>Compiled by: gcc version 2.95.2 19991024 (release) as [ELF 32-bit LSB executable 80386, dynamically linked, stripped, no debug (SVR5 ABI)] at systime Fri Jul 13 13:02:21 CEST 2018</p>
x86_Minix_32	<p>file fastlisp: ELF 32-bit LSB executable, Intel 80386, version 1, statically linked, stripped</p> <p>Compiled on: Minix MinixVM.ESXsrv.net 3.2.0 i686</p> <p>Compiled by: clang version 2.9 (trunk) [i386-pc-minix] as [ELF executable] at systime Fri Jul 13 13:01:23 GMT 2018</p>
x86_Android_32	<p>file fastlisp: ELF 32-bit LSB executable, Intel 80386, version 1 (SYSV), dynamically linked (uses shared libs), stripped</p> <p>Compiled on: Linux DebianLinux 4.9.0-3-amd64 #1 SMP Debian 4.9.30-2+deb9u5 (2017-09-19) x86_64</p> <p>Compiled by: gcc version 4.9.x 20150123 (prerelease) (GCC) (cross-toolchain) (m32 i686-linux-android -D ANDROID API =26) as [ELF 32-bit LSB executable, Intel 80386, version 1 (SYSV), dynamically linked (uses shared libs), stripped] at systime Fri Jul 13 13:01:41 CEST 2018</p>
x86_Android_32_clang	<p>file fastlisp: ELF 32-bit LSB executable, Intel 80386, version 1 (SYSV), dynamically linked (uses shared libs), stripped</p> <p>Compiled on: Linux DebianLinux 4.9.0-3-amd64 #1 SMP Debian 4.9.30-2+deb9u5 (2017-09-19) x86_64</p> <p>Compiled by: clang version 5.0.300080 (based on LLVM 5.0.300080) (cross-toolchain) (m32 i686-linux-android -D ANDROID API =26) as [ELF 32-bit LSB executable, Intel 80386, version 1 (SYSV), dynamically linked (uses shared libs), stripped] at systime Fri Jul 13 13:09:56 CEST 2018</p>
x86-64_Windows-Cygwin_64	<p>file fastlisp.exe: PE32+ executable (console) x86-64 (stripped to external PDB), for MS Windows</p> <p>Compiled on: CYGWIN NT-6.1 WINDOWS7VM 2.10.0(0.325/5/3) 2018-02-02 15:16 x86_64 Cygwin</p> <p>Compiled by: gcc version 6.4.0 (GCC) as [PE32+ executable (console) x86-64 (stripped to external PDB), for MS Windows] at systime Fri Jul 13 13:09:54 CEST 2018</p>
x86-64_Linux_64	<p>file fastlisp: ELF 64-bit LSB executable, x86-64, version 1 (SYSV), dynamically linked (uses shared libs), for GNU/Linux 2.6.32, stripped</p> <p>Compiled on: Linux RedHatELS72VM 3.10.0-514.26.2.el7.x86_64 #1 SMP Fri Jun 30 05:26:04 UTC 2017 x86_64</p> <p>Compiled by: gcc version 4.8.5 20150623 (Red Hat 4.8.5-11) (GCC) as [ELF 64-bit LSB executable, x86-64, version 1 (SYSV), dynamically linked (uses shared libs), for GNU/Linux 2.6.32, stripped] at systime Fri Jul 13 13:01:55 CEST 2018</p>

Appendix C

x86-64_Linux_64_clang	<p>file fastlisp: ELF 64-bit LSB executable, x86-64, version 1 (SYSV), dynamically linked (uses shared libs), for GNU/Linux 2.6.32, stripped</p> <p>Compiled on: Linux RedHatELS72VM 3.10.0-514.26.2.el7.x86_64 #1 SMP Fri Jun 30 05:26:04 UTC 2017 x86_64</p> <p>Compiled by: clang version 3.8.1 (tags/RELEASE_381/final) as [ELF 64-bit LSB executable, x86-64, version 1 (SYSV), dynamically linked (uses shared libs), for GNU/Linux 2.6.32, stripped] at systime Fri Jul 13 13:05:49 CEST 2018</p>
x86-64_Linux_64_icc	<p>file fastlisp: ELF 64-bit LSB executable, x86-64, version 1 (SYSV), dynamically linked (uses shared libs), for GNU/Linux 2.6.18, stripped</p> <p>Compiled on: Linux RedHatELS62VM 2.6.32-220.13.1.el6.x86_64 #1 SMP Thu Mar 29 11:46:40 EDT 2012 x86_64</p> <p>Compiled by: icc Intel(R) C Intel(R) 64 Compiler XE for applications running on Intel(R) 64, Version 15.0.0.090 Build 20140723 (Copyright (C) 1985-2014 Intel Corporation. All rights reserved.) as [ELF 64-bit LSB executable, x86-64, version 1 (SYSV), dynamically linked (uses shared libs), for GNU/Linux 2.6.18, stripped] at systime Fri Jul 13 13:02:48 CEST 2018</p>
x86-64_FreeBSD_64	<p>file fastlisp: ELF 64-bit LSB executable, x86-64, version 1 (FreeBSD), dynamically linked (uses shared libs), for FreeBSD 11.0 (1100122), stripped</p> <p>Compiled on: FreeBSD FreeBSD11VM 11.0-RELEASE-p1 FreeBSD 11.0-RELEASE-p1 #0 r306420: Thu Sep 29 01:43:23 UTC 2016 root@releng2.nyi.freebsd.org:/usr/obj/usr/src/sys/GENERIC amd64</p> <p>Compiled by: gcc version 4.8.5 (FreeBSD Ports Collection) as [ELF 64-bit LSB executable, x86-64, version 1 (FreeBSD), dynamically linked (uses shared libs), for FreeBSD 11.0 (1100122), FreeBSD-style, stripped] at systime Fri Jul 13 13:02:12 CEST 2018</p>
x86-64_FreeBSD_64_clang	<p>file fastlisp: ELF 64-bit LSB executable, x86-64, version 1 (FreeBSD), dynamically linked (uses shared libs), for FreeBSD 11.0 (1100122), stripped</p> <p>Compiled on: FreeBSD FreeBSD11VM 11.0-RELEASE-p1 FreeBSD 11.0-RELEASE-p1 #0 r306420: Thu Sep 29 01:43:23 UTC 2016 root@releng2.nyi.freebsd.org:/usr/obj/usr/src/sys/GENERIC amd64</p> <p>Compiled by: FreeBSD clang version 3.8.0 (tags/RELEASE_380/final 262564) (based on LLVM 3.8.0) as [ELF 64-bit LSB executable, x86-64, version 1 (FreeBSD), dynamically linked (uses shared libs), for FreeBSD 11.0 (1100122), FreeBSD-style, stripped] at systime Fri Jul 13 13:07:02 CEST 2018</p>
x86-64_OpenBSD_64	<p>file fastlisp: ELF 64-bit LSB executable, x86-64, version 1 (SYSV), dynamically linked (uses shared libs), for OpenBSD, stripped</p> <p>Compiled on: OpenBSD OpenBSD64VM.ESXsrv.net 5.4 GENERIC#37 amd64</p> <p>Compiled by: gcc version 4.2.1 20070719 (OpenBSD/amd64 system compiler) as [ELF 64-bit LSB executable, x86-64, version 1, for OpenBSD, dynamically linked (uses shared libs), stripped] at systime Fri Jul 13 13:01:17 CEST 2018</p>

x86-64_NetBSD_64	<p>file fastlisp: ELF 64-bit LSB executable, x86-64, version 1 (SYSV), dynamically linked (uses shared libs), for NetBSD 6.1.2, stripped</p> <p>Compiled on: NetBSD NetBSD64VM.ESXsrv.net 6.1.2 NetBSD 6.1.2 (GENERIC) amd64</p> <p>Compiled by: gcc version 4.5.3 (NetBSD nb2 20110806) as [ELF 64-bit LSB executable, x86-64, version 1 (SYSV), dynamically linked (uses shared libs), for NetBSD 6.1.2, stripped] at systime Fri Jul 13 13:02:04 CEST 2018</p>
x86-64_MacOS_64	<p>file fastlisp: Mach-O 64-bit x86_64 executable</p> <p>Compiled on: Darwin MacIntel 14.5.0 Darwin Kernel Version 14.5.0: Tue Apr 11 16:12:42 PDT 2017; root:xnu-2782.50.9.2.3-1/RELEASE_ARM_T8020 x86_64</p> <p>Compiled by: Apple LLVM version 7.0.2 (clang-700.1.81) as [Mach-O 64-bit executable x86_64] at systime Fri Jul 13 13:02:16 CEST 2018</p>
x86-64_SunOS_64	<p>file fastlisp: ELF 64-bit LSB executable, x86-64, version 1, dynamically linked (uses shared libs), stripped, uses FPU CMOV FXSR SSE SSE2</p> <p>Compiled on: SunOS SunOSi386VM 5.10 Generic_150401-46 i86pc i386</p> <p>Compiled by: cc: Sun C 5.10 SunOS i386 Patch 1423 63-09 2012/08/15 as [ELF 64-bit LSB executable AMD64 Version 1 [SSE2 SSE FXSR CMOV FPU], dynamically linked, stripped] at systime Fri Jul 13 13:03:40 CEST 2018</p>
x86-64_SunOS_64_gcc	<p>file fastlisp: ELF 64-bit LSB executable, x86-64, version 1, dynamically linked (uses shared libs), stripped</p> <p>Compiled on: SunOS SunOSi386VM 5.10 Generic_150401-46 i86pc i386</p> <p>Compiled by: gcc version 3.4.3 (cs1-sol210-3 4-branch+sol rpath) as [ELF 64-bit LSB executable AMD64 Version 1, dynamically linked, stripped] at systime Fri Jul 13 13:15:15 CEST 2018</p>
x86-64_Android_64	<p>file fastlisp: ELF 64-bit LSB executable, x86-64, version 1 (SYSV), dynamically linked (uses shared libs), stripped</p> <p>Compiled on: Linux DebianLinux 4.9.0-3-amd64 #1 SMP Debian 4.9.30-2+deb9u5 (2017-09-19) x86_64</p> <p>Compiled by: gcc version 4.9.x 20150123 (prerelease) (GCC) (cross-toolchain) (m64 x86_64-linux-android -D ANDROID_API =26) as [ELF 64-bit LSB executable, x86-64, version 1 (SYSV), dynamically linked (uses shared libs), stripped] at systime Fri Jul 13 13:03:08 CEST 2018</p>
x86-64_Android_64_clang	<p>file fastlisp: ELF 64-bit LSB executable, x86-64, version 1 (SYSV), dynamically linked (uses shared libs), stripped</p> <p>Compiled on: Linux DebianLinux 4.9.0-3-amd64 #1 SMP Debian 4.9.30-2+deb9u5 (2017-09-19) x86_64</p> <p>Compiled by: clang version 5.0.300080 (based on LLVM 5.0.300080) (cross-toolchain) (m64 x86_64-linux-android -D ANDROID_API =26) as [ELF 64-bit LSB executable, x86-64, version 1 (SYSV), dynamically linked (uses shared libs), stripped] at systime Fri Jul 13 13:11:10 CEST 2018</p>

Appendix C

VAX_Ultrix_32	<p>file fastlisp: a.out little-endian 32-bit demand paged pure executable</p> <p>Compiled on: ULTRIX DECultrixVAX 4.5 0 VAX</p> <p>Compiled by: gcc version 2.7.2 as [VAX demand paged pure executable] at systime Fri Jul 13 13:05:45 MET DST 2018</p>
Alpha_Tru64OSF1_64	<p>file fastlisp: COFF format alpha demand paged executable dynamically linked stripped - version 3.14-2</p> <p>Compiled on: OSF1 DECTru64alpha V5.1 2650 alpha</p> <p>Compiled by: Compaq C V6.5-303 (dtk) on HP Tru64 UNIX V5.1B (Rev. 2650) Compiler Driver V6.5-302 (dtk) cc Driver as [COFF format alpha dynamically linked, demand paged executable or object module stripped - version 3.14-2] at systime Fri Jul 13 13:10:34 WEST 2018</p>
Alpha_Linux_64	<p>file fastlisp: ELF 64-bit LSB executable, Alpha (unofficial), version 1 (SYSV), dynamically linked (uses shared libs), for GNU/Linux 2.6.9, stripped</p> <p>Compiled on: Linux AlphaLinux 2.6.26-2-alpha-generic #1 Sun Mar 4 21:08:03 UTC 2012 alpha</p> <p>Compiled by: gcc version 4.2.4 (Debian 4.2.4-6) as [ELF 64-bit LSB executable, Alpha (unofficial), version 1 (SYSV), dynamically linked (uses shared libs), for GNU/Linux 2.6.9, stripped] at systime Fri Jul 13 13:02:22 CEST 2018</p>
Alpha_FreeBSD_64	<p>file fastlisp: ELF 64-bit LSB executable, Alpha (unofficial), version 1 (FreeBSD), dynamically linked (uses shared libs), for FreeBSD 6.4, stripped</p> <p>Compiled on: FreeBSD AlphaBSD 6.4-RELEASE FreeBSD 6.4-RELEASE #0: Sun Nov 30 07:00:37 UTC 2008 root@ds10.wbnet:/usr/obj/usr/src/sys/GENERIC alpha</p> <p>Compiled by: gcc version 3.4.6 [FreeBSD] 20060305 (Configured with: FreeBSD/alpha system compiler) as [ELF 64-bit LSB executable, Alpha (unofficial), version 1 (FreeBSD), for FreeBSD 6.4, dynamically linked (uses shared libs), FreeBSD-style, stripped] at systime Fri Jul 13 13:08:55 CEST 2018</p>
IA-64_HP-UX_32	<p>file fastlisp: ELF 32-bit MSB executable, IA-64, version 1, dynamically linked (uses shared libs), stripped</p> <p>Compiled on: HP-UX IA64hpux B.11.31 U ia64 289719 0201</p> <p>Compiled by: cc: HP C/aC++ B3910B A.06.28 [Nov 21 2013] as [ELF-32 executable object file - IA64] at systime Fri Jul 13 13:04:36 MESZ 2018</p>
IA-64_HP-UX_32_gcc	<p>file fastlisp: ELF 32-bit MSB executable, IA-64, version 1, dynamically linked (uses shared libs), stripped</p> <p>Compiled on: HP-UX IA64hpux B.11.31 U ia64 289719 0201</p> <p>Compiled by: gcc version 4.7.2 (GCC) (ia64-hp-hpux11.31) as [ELF-32 executable object file - IA64] at systime Fri Jul 13 14:21:52 MESZ 2018</p>

IA-64_HP-UX_64	<p>file fastlisp: ELF 64-bit MSB executable, IA-64, version 1, dynamically linked (uses shared libs), stripped</p> <p>Compiled on: HP-UX IA64hpux B.11.31 U ia64 289719 0201</p> <p>Compiled by: cc: HP C/aC++ B3910B A.06.28 [Nov 21 2013] as [ELF-64 executable object file - IA64] at systime Fri Jul 13 13:18:27 MESZ 2018</p>
IA-64_HP-UX_64_gcc	<p>file fastlisp: ELF 64-bit MSB executable, IA-64, version 1, dynamically linked (uses shared libs), stripped</p> <p>Compiled on: HP-UX IA64hpux B.11.31 U ia64 289719 0201</p> <p>Compiled by: gcc version 4.7.2 (GCC) (ia64-hp-hpux11.31) as [ELF-64 executable object file - IA64] at systime Fri Jul 13 14:24:23 MESZ 2018</p>
IA-64_Linux_64	<p>file fastlisp: ELF 64-bit LSB executable, IA-64, version 1 (SYSV), dynamically linked (uses shared libs), for GNU/Linux 2.6.26, stripped</p> <p>Compiled on: Linux IA64-Linux 2.6.32-5-mckinley #1 SMP Tue May 13 19:10:46 UTC 2014 ia64</p> <p>Compiled by: gcc version 4.6.3 (Debian 4.6.3-14) as [ELF 64-bit LSB executable, IA-64, version 1 (SYSV), dynamically linked (uses shared libs), for GNU/Linux 2.6.26, stripped] at systime Fri Jul 13 13:02:21 CEST 2018</p>
IA-64_FreeBSD_64	<p>file fastlisp: ELF 64-bit LSB executable, IA-64, version 1 (FreeBSD), dynamically linked (uses shared libs), for FreeBSD 10.3, stripped</p> <p>Compiled on: FreeBSD ItaniumBSD 10.3-RELEASE FreeBSD 10.3-RELEASE #0 r297264: Fri Mar 25 04:43:22 UTC 2016 root@releng1.nyi.freebsd.org:/usr/obj/ia64.ia64/usr/src/sys/GENERIC ia64</p> <p>Compiled by: gcc version 4.2.1 20070831 patched [FreeBSD] (Configured with: FreeBSD/ia64 system compiler) as [ELF 64-bit LSB executable, IA-64, version 1 (FreeBSD), dynamically linked (uses shared libs), for FreeBSD 10.3, stripped] at systime Fri Jul 13 13:01:48 CEST 2018</p>
XeonPhiMIC_Linux_64	<p>file fastlisp: ELF 64-bit LSB executable, Intel K10M, version 1 (SYSV), dynamically linked (uses shared libs), for GNU/Linux 2.4.0, stripped</p> <p>Compiled on: Linux RedHatELS62VM 2.6.32-220.13.1.el6.x86_64 #1 SMP Thu Mar 29 11:46:40 EDT 2012 x86_64</p> <p>Compiled by: icc Intel(R) C Intel(R) 64 Compiler XE for applications running on Intel(R) 64, Version 15.0.0.090 Build 20140723 (Copyright (C) 1985-2014 Intel Corporation. All rights reserved.) as [ELF 64-bit LSB executable, Intel K10M, version 1 (SYSV), dynamically linked (uses shared libs), for GNU/Linux 2.4.0, stripped] at systime Fri Jul 13 13:01:31 CEST 2018</p>
XeonPhiMIC_Linux_64_gcc	<p>file fastlisp: ELF 64-bit LSB executable, Intel K10M, version 1 (SYSV), dynamically linked (uses shared libs), for GNU/Linux 2.4.0, stripped</p> <p>Compiled on: Linux RedHatELS62VM 2.6.32-220.13.1.el6.x86_64 #1 SMP Thu Mar 29 11:46:40 EDT 2012 x86_64</p> <p>Compiled by: gcc version 4.7.0 20110509 (experimental) 4.7.0 (GCC) (cross-toolchain) as [ELF 64-bit LSB executable, Intel K10M, version 1 (SYSV), dynamically linked (uses shared libs), for GNU/Linux 2.4.0, stripped] at systime Fri Jul 13 13:06:07 CEST 2018</p>

Appendix C

MCSTelbrus_Linux_32	<p>file fastlisp: ELF 32-bit LSB executable, MCST Elbrus, version 1 (SYSV), dynamically linked (uses shared libs), for GNU/Linux 2.6.33, stripped</p> <p>Compiled on: Linux debian4babayan-64 2.6.33-elbrus.033.3.42 #1 SMP Thu Apr 23 22:28:28 MSK 2015 e2k</p> <p>Compiled by: lcc:1.19.11:Dec-13-2014:e2k-2c+-linux (gcc version 4.4.0 compatible) as [ELF 32-bit LSB executable, MCST Elbrus, version 1 (SYSV), dynamically linked (uses shared libs), for GNU/Linux 2.6.33, stripped] at systime Fri Jul 13 14:06:29 MSK 2018</p>
MCSTelbrus_Linux_64	<p>file fastlisp: ELF 64-bit LSB executable, MCST Elbrus, version 1 (SYSV), dynamically linked (uses shared libs), for GNU/Linux 2.6.33, stripped</p> <p>Compiled on: Linux debian4babayan-64 2.6.33-elbrus.033.3.42 #1 SMP Thu Apr 23 22:28:28 MSK 2015 e2k</p> <p>Compiled by: lcc:1.19.11:Dec-13-2014:e2k-2c+-linux (gcc version 4.4.0 compatible) as [ELF 64-bit LSB executable, MCST Elbrus, version 1 (SYSV), dynamically linked (uses shared libs), for GNU/Linux 2.6.33, stripped] at systime Fri Jul 13 14:15:11 MSK 2018</p>
PA-RISC_HP-UX_32	<p>file fastlisp: PA-RISC1.1 shared executable dynamically linked</p> <p>Compiled on: HP-UX c8k-HPUX B.11.23 U 9000/785 4042425048</p> <p>Compiled by: HP ANSI C / C++ B3910B C.03.70 (HP92453-01 B.11.11.16 HP C Compiler) as [PA-RISC1.1 shared executable dynamically linked] at systime Fri Jul 13 13:02:07 METDST 2018</p>
PA-RISC_HP-UX_32_gcc	<p>file fastlisp: PA-RISC1.1 shared executable dynamically linked</p> <p>Compiled on: HP-UX c8k-HPUX B.11.23 U 9000/785 4042425048</p> <p>Compiled by: gcc version 4.7.1 (GCC) (hppa1.1-hp-ux11.11) as [PA-RISC1.1 shared executable dynamically linked] at systime Fri Jul 13 13:55:38 METDST 2018</p>
PA-RISC_HP-UX_64	<p>file fastlisp: ELF 64-bit MSB executable, PA-RISC, 2.0 (LP64) version 1, dynamically linked (uses shared libs), stripped</p> <p>Compiled on: HP-UX c8k-HPUX B.11.23 U 9000/785 4042425048</p> <p>Compiled by: HP ANSI C / C++ B3910B C.03.70 (HP92453-01 B.11.11.16 HP C Compiler) as [ELF-64 executable object file - PA-RISC 2.0 (LP64) / HPPA64 (PA-RISC2.0W)] at systime Fri Jul 13 13:10:52 METDST 2018</p>
PA-RISC_HP-UX_64_gcc	<p>file fastlisp: ELF 64-bit MSB executable, PA-RISC, 2.0 (LP64) version 1, dynamically linked (uses shared libs), stripped</p> <p>Compiled on: HP-UX c8k-HPUX B.11.23 U 9000/785 4042425048</p> <p>Compiled by: gcc version 4.7.1 (GCC) (hppa64-hp-ux11.11) as [ELF-64 executable object file - PA-RISC 2.0 (LP64) / HPPA64 (PA-RISC2.0W)] at systime Fri Jul 13 13:59:32 METDST 2018</p>

PA-RISC_Linux_32	<p>file fastlisp: ELF 32-bit MSB executable, PA-RISC, version 1 (GNU/Linux), dynamically linked (uses shared libs), for GNU/Linux 2.6.32, stripped</p> <p>Compiled on: Linux c8k-Linux 3.16.0-4-parisc64-smp #1 SMP Debian 3.16.7-ckt4-3 (2015-02-03) parisc64</p> <p>Compiled by: gcc version 4.9.2 (Debian 4.9.2-10+b2) as [ELF 32-bit MSB executable, PA-RISC, version 1 (GNU/Linux), dynamically linked (uses shared libs), for GNU/Linux 2.6.32, stripped] at systime Fri Jul 13 13:02:03 CEST 2018</p>
SPARC_SunOS_32	<p>file fastlisp: ELF 32-bit MSB executable, SPARC32 PLUS, V8+ Required, version 1, dynamically linked (uses shared libs), stripped</p> <p>Compiled on: SunOS SunOS_Ultra45 5.10 Generic_147 147-26 sun4u sparc</p> <p>Compiled by: cc: Sun C 5.10 SunOS sparc Patch 141 861-09 2012/08/15 as [ELF 32-bit MSB executable SPARC32PLUS Version 1, V8+ Required, dynamically linked, stripped] at systime Fri Jul 13 13:02:36 CEST 2018</p>
SPARC_SunOS_32_gcc	<p>file fastlisp: ELF 32-bit MSB executable, SPARC, version 1, dynamically linked (uses shared libs), stripped</p> <p>Compiled on: SunOS SunOS_Ultra45 5.10 Generic_147 147-26 sun4u sparc</p> <p>Compiled by: gcc version 3.4.3 (csl-sol210-3 4-branch+sol_rpath) as [ELF 32-bit MSB executable SPARC Version 1, dynamically linked, stripped] at systime Fri Jul 13 13:35:06 CEST 2018</p>
SPARC_SunOS_64	<p>file fastlisp: ELF 64-bit MSB executable, SPARC V9, total store ordering, version 1, dynamically linked (uses shared libs), stripped</p> <p>Compiled on: SunOS SunOS_Ultra45 5.10 Generic_147 147-26 sun4u sparc</p> <p>Compiled by: cc: Sun C 5.10 SunOS sparc Patch 141 861-09 2012/08/15 as [ELF 64-bit MSB executable SPARC V9 Version 1, dynamically linked, stripped] at systime Fri Jul 13 13:08:19 CEST 2018</p>
SPARC_SunOS_64_gcc	<p>file fastlisp: ELF 64-bit MSB executable, SPARC V9, total store ordering, version 1, dynamically linked (uses shared libs), stripped</p> <p>Compiled on: SunOS SunOS_Ultra45 5.10 Generic_147 147-26 sun4u sparc</p> <p>Compiled by: gcc version 3.4.3 (csl-sol210-3 4-branch+sol_rpath) as [ELF 64-bit MSB executable SPARC V9 Version 1, dynamically linked, stripped] at systime Fri Jul 13 13:35:43 CEST 2018</p>
SPARC_Linux_32	<p>file fastlisp: ELF 32-bit MSB executable, SPARC32 PLUS, V8+ Required, version 1 (SYSV), dynamically linked (uses shared libs), for GNU/Linux 3.2.0, stripped</p> <p>Compiled on: Linux SunUltra45 4.9.0-2-sparc64-smp #1 SMP Debian 4.9.13-1 (2017-02-27) sparc64</p> <p>Compiled by: gcc version 6.4.0 20171010 (Debian 6.4.0-8) as [ELF 32-bit MSB executable, SPARC32PLUS, V8+ Required, total store ordering, version 1 (SYSV), dynamically linked (uses shared libs), for GNU/Linux 3.2.0, stripped] at systime Fri Jul 13 13:01:42 CEST 2018</p>

Appendix C

SPARC_Linux_64	<p>file fastlisp: ELF 64-bit MSB executable, SPARC V9, relaxed memory ordering, version 1 (SYSV), dynamically linked (uses shared libs), for GNU/Linux 3.2.0, stripped</p> <p>Compiled on: Linux SunUltra45 4.9.0-2-sparc64-smp #1 SMP Debian 4.9.13-1 (2017-02-27) sparc64</p> <p>Compiled by: gcc version 6.4.0 20171010 (Debian 6.4.0-8) as [ELF 64-bit MSB executable, SPARC V9, relaxed memory ordering, version 1 (SYSV), dynamically linked (uses shared libs), for GNU/Linux 3.2.0, stripped] at systime Fri Jul 13 13:05:36 CEST 2018</p>
SPARC_Linux_64_clang	<p>file fastlisp: ELF 64-bit MSB executable, SPARC V9, relaxed memory ordering, version 1 (SYSV), dynamically linked (uses shared libs), for GNU/Linux 3.2.0, stripped</p> <p>Compiled on: Linux SunUltra45 4.9.0-2-sparc64-smp #1 SMP Debian 4.9.13-1 (2017-02-27) sparc64</p> <p>Compiled by: clang version 3.8.1-24 (tags/RELEASE_381/final) as [ELF 64-bit MSB executable, SPARC V9, relaxed memory ordering, version 1 (SYSV), dynamically linked (uses shared libs), for GNU/Linux 3.2.0, stripped] at systime Fri Jul 13 13:01:55 CEST 2018</p>
SPARC_FreeBSD_64	<p>file fastlisp: ELF 64-bit MSB executable, SPARC V9, relaxed memory ordering, version 1 (FreeBSD), dynamically linked (uses shared libs), FreeBSD-style, for FreeBSD 11.0 (1100122), stripped</p> <p>Compiled on: FreeBSD SparcBSD 11.0-RELEASE-p1 FreeBSD 11.0-RELEASE-p1 #0 r306420: Thu Sep 29 08:00:05 UTC 2016 root@releng2.nyi.freebsd.org:/usr/obj/sparc64.sparc64/usr/src/sys/GENERIC sparc64</p> <p>Compiled by: gcc version 4.2.1 20070831 patched [FreeBSD] (Configured with: FreeBSD/sparc64 system compiler) as [ELF 64-bit MSB executable, SPARC V9, relaxed memory ordering, version 1 (FreeBSD), dynamically linked, FreeBSD-style, for FreeBSD 11.0 (1100122), stripped] at systime Fri Jul 13 13:05:54 CEST 2018</p>
MIPS_IRIX_32	<p>file fastlisp: ELF 32-bit MSB executable, MIPS, N32 MIPS-IV version 1 (SYSV), dynamically linked (uses shared libs), stripped</p> <p>Compiled on: IRIX64 SGImipsIRIX 6.5 07202013 IP30</p> <p>Compiled by: MIPSpro Compilers: Version 7.4.4m as [ELF N32 MSB mips-4 dynamic executable MIPS - version 1] at systime Fri Jul 13 13:05:49 CEST 2018</p>
MIPS_IRIX_32_gcc	<p>file fastlisp: ELF 32-bit MSB executable, MIPS, N32 MIPS-IV version 1 (SYSV), dynamically linked (uses shared libs), stripped</p> <p>Compiled on: IRIX64 SGImipsIRIX 6.5 07202013 IP30</p> <p>Compiled by: gcc version 4.7.1 (GCC) (mips-sgi-irix6.5) as [ELF N32 MSB mips-4 dynamic executable MIPS - version 1] at systime Fri Jul 13 13:32:24 CEST 2018</p>
MIPS_IRIX_64	<p>file fastlisp: ELF 64-bit MSB executable, MIPS, MIPS-IV version 1 (SYSV), dynamically linked (uses shared libs), stripped</p> <p>Compiled on: IRIX64 SGImipsIRIX 6.5 07202013 IP30</p> <p>Compiled by: MIPSpro Compilers: Version 7.4.4m as [ELF 64-bit MSB mips-4 dynamic executable MIPS - version 1] at systime Fri Jul 13 13:12:43 CEST 2018</p>

MIPS_IRIX_64_gcc	<p>file fastlisp: ELF 64-bit MSB executable, MIPS, MIPS-IV version 1 (SYSV), dynamically linked (uses shared libs), stripped</p> <p>Compiled on: IRIX64 SGImipsIRIX 6.5 07202013 IP30</p> <p>Compiled by: gcc version 4.7.1 (GCC) (mips-sgi-irix6.5) as [ELF 64-bit MSB mips-4 dynamic executable MIPS - version 1] at systime Fri Jul 13 13:42:30 CEST 2018</p>
MIPS_Linux_32	<p>file fastlisp: ELF 32-bit MSB executable, MIPS, MIPS-I version 1 (SYSV), dynamically linked (uses shared libs), for GNU/Linux 2.6.32, stripped</p> <p>Compiled on: Linux RedHatELS62VM 2.6.32-220.13.1.el6.x86_64 #1 SMP Thu Mar 29 11:46:40 EDT 2012 x86_64</p> <p>Compiled by: gcc version 5.3.0 (GCC) (cross-toolchain) as [ELF 32-bit MSB executable, MIPS, MIPS-I version 1 (SYSV), dynamically linked (uses shared libs), for GNU/Linux 2.6.32, stripped] at systime Fri Jul 13 13:01:17 CEST 2018</p>
MIPS_Linux_64	<p>file fastlisp: ELF 64-bit MSB executable, MIPS, MIPS-III version 1 (SYSV), dynamically linked (uses shared libs), for GNU/Linux 2.6.32, stripped</p> <p>Compiled on: Linux RedHatELS62VM 2.6.32-220.13.1.el6.x86_64 #1 SMP Thu Mar 29 11:46:40 EDT 2012 x86_64</p> <p>Compiled by: gcc version 5.3.0 (GCC) (cross-toolchain) as [ELF 64-bit MSB executable, MIPS, MIPS-III version 1 (SYSV), dynamically linked (uses shared libs), for GNU/Linux 2.6.32, stripped] at systime Fri Jul 13 13:02:36 CEST 2018</p>
MIPSEL_Linux_32	<p>file fastlisp: ELF 32-bit LSB executable, MIPS, MIPS-I version 1 (SYSV), dynamically linked (uses shared libs), for GNU/Linux 2.6.32, stripped</p> <p>Compiled on: Linux RedHatELS62VM 2.6.32-220.13.1.el6.x86_64 #1 SMP Thu Mar 29 11:46:40 EDT 2012 x86_64</p> <p>Compiled by: gcc version 5.3.0 (GCC) (cross-toolchain) as [ELF 32-bit LSB executable, MIPS, MIPS-I version 1 (SYSV), dynamically linked (uses shared libs), for GNU/Linux 2.6.32, stripped] at systime Fri Jul 13 13:01:18 CEST 2018</p>
MIPSEL_Linux_64	<p>file fastlisp: ELF 64-bit LSB executable, MIPS, MIPS-III version 1 (SYSV), dynamically linked (uses shared libs), for GNU/Linux 2.6.32, stripped</p> <p>Compiled on: Linux RedHatELS62VM 2.6.32-220.13.1.el6.x86_64 #1 SMP Thu Mar 29 11:46:40 EDT 2012 x86_64</p> <p>Compiled by: gcc version 5.3.0 (GCC) (cross-toolchain) as [ELF 64-bit LSB executable, MIPS, MIPS-III version 1 (SYSV), dynamically linked (uses shared libs), for GNU/Linux 2.6.32, stripped] at systime Fri Jul 13 13:02:35 CEST 2018</p>
MIPSEL_Android_32	<p>file fastlisp: ELF 32-bit LSB executable, MIPS, MIPS32 version 1 (SYSV), dynamically linked (uses shared libs), stripped</p> <p>Compiled on: Linux DebianLinux 4.9.0-3-amd64 #1 SMP Debian 4.9.30-2+deb9u5 (2017-09-19) x86_64</p> <p>Compiled by: gcc version 4.9.x 20150123 (prerelease) (GCC) (cross-toolchain) (mips32 mipsel-linux-android -D ANDROID API =26) as [ELF 32-bit LSB executable, MIPS, MIPS32 version 1 (SYSV), dynamically linked (uses shared libs), stripped] at systime Fri Jul 13 13:01:28 CEST 2018</p>

Appendix C

MIPSEL_Android_32_clang	<p>file fastlisp: ELF 32-bit LSB executable, MIPS, MIPS32 version 1 (SYSV), dynamically linked (uses shared libs), stripped</p> <p>Compiled on: Linux DebianLinux 4.9.0-3-amd64 #1 SMP Debian 4.9.30-2+deb9u5 (2017-09-19) x86_64</p> <p>Compiled by: clang version 5.0.300080 (based on LLVM 5.0.300080) (cross-toolchain) (mips32 mipsel-linux-android -D ANDROID_API=26) as [ELF 32-bit LSB executable, MIPS, MIPS32 version 1 (SYSV), dynamically linked (uses shared libs), stripped] at systime Fri Jul 13 13:11:51 CEST 2018</p>
MIPSEL_Android_64	<p>file fastlisp: ELF 64-bit LSB executable, MIPS, version 1 (SYSV), dynamically linked (uses shared libs), stripped</p> <p>Compiled on: Linux DebianLinux 4.9.0-3-amd64 #1 SMP Debian 4.9.30-2+deb9u5 (2017-09-19) x86_64</p> <p>Compiled by: gcc version 4.9.x 20150123 (prerelease) (GCC) (cross-toolchain) (mips64 mips64el-linux-android -D ANDROID_API=26) as [ELF 64-bit LSB executable, MIPS, version 1 (SYSV), dynamically linked (uses shared libs), stripped] at systime Fri Jul 13 13:03:14 CEST 2018</p>
MIPSEL_Android_64_clang	<p>file fastlisp: ELF 64-bit LSB executable, MIPS, version 1 (SYSV), dynamically linked (uses shared libs), stripped</p> <p>Compiled on: Linux DebianLinux 4.9.0-3-amd64 #1 SMP Debian 4.9.30-2+deb9u5 (2017-09-19) x86_64</p> <p>Compiled by: clang version 5.0.300080 (based on LLVM 5.0.300080) (cross-toolchain) (mips64 mips64el-linux-android -D ANDROID_API=26) as [ELF 64-bit LSB executable, MIPS, version 1 (SYSV), dynamically linked (uses shared libs), stripped] at systime Fri Jul 13 13:13:02 CEST 2018</p>
PowerPC_AIX_32	<p>file fastlisp: executable (RISC System/6000 V3.1) or obj module</p> <p>Compiled on: AIX IBMaix 1 7 00CE8BB34C00</p> <p>Compiled by: IBM XL C/C++ for AIX, V13.1.3 (5725-C72, 5765-J07) Version: 13.01.0003.0000 as [executable (RISC System/6000) or object module] at systime Fri Jul 13 13:03:10 DFT 2018</p>
PowerPC_AIX_32_gcc	<p>file fastlisp: executable (RISC System/6000 V3.1) or obj module</p> <p>Compiled on: AIX IBMaix 1 7 00CE8BB34C00</p> <p>Compiled by: gcc version 4.9.4 (GCC) (powerpc-ibm-aix7.1.0.0) as [executable (RISC System/6000) or object module] at systime Fri Jul 13 13:41:59 DFT 2018</p>
PowerPC_AIX_64	<p>file fastlisp: 64-bit XCOFF executable or object module</p> <p>Compiled on: AIX IBMaix 1 7 00CE8BB34C00</p> <p>Compiled by: IBM XL C/C++ for AIX, V13.1.3 (5725-C72, 5765-J07) Version: 13.01.0003.0000 as [64-bit XCOFF executable or object module] at systime Fri Jul 13 13:09:43 DFT 2018</p>
PowerPC_AIX_64_gcc	<p>file fastlisp: 64-bit XCOFF executable or object module</p> <p>Compiled on: AIX IBMaix 1 7 00CE8BB34C00</p> <p>Compiled by: gcc version 4.9.4 (GCC) (powerpc-ibm-aix7.1.0.0) as [64-bit XCOFF executable or object module] at systime Fri Jul 13 13:44:21 DFT 2018</p>

PowerPC_MacOS_32	<p>file fastlisp: Mach-O ppc_7400 executable</p> <p>Compiled on: Darwin PowerG5MacOSX 9.8.0 Darwin Kernel Version 9.8.0: Wed Jul 15 16:57:01 PDT 2009; root:xnu-1228.15.4~1/RELEASE_PPC Power Macintosh</p> <p>Compiled by: gcc version 4.2.1 (Apple Inc. build 5577) as [Mach-O executable ppc] at systime Fri Jul 13 13:01:40 CEST 2018</p>
PowerPC_MacOS_64	<p>file fastlisp: Mach-O ppc64 executable</p> <p>Compiled on: Darwin PowerG5MacOSX 9.8.0 Darwin Kernel Version 9.8.0: Wed Jul 15 16:57:01 PDT 2009; root:xnu-1228.15.4~1/RELEASE_PPC Power Macintosh</p> <p>Compiled by: gcc version 4.2.1 (Apple Inc. build 5577) as [Mach-O 64-bit executable ppc64] at systime Fri Jul 13 13:06:13 CEST 2018</p>
PowerPC_Linux_32	<p>file fastlisp: ELF 32-bit MSB executable, PowerPC or cisco 4500, version 1 (SYSV), dynamically linked (uses shared libs), for GNU/Linux 2.6.32, stripped</p> <p>Compiled on: Linux IBMpower 3.16.0-4-powerpc64 #1 SMP Debian 3.16.43-2+deb8u5 (2017-09-19) ppc64</p> <p>Compiled by: gcc version 4.9.2 (Debian 4.9.2-10) as [ELF 32-bit MSB executable, PowerPC or cisco 4500, version 1 (SYSV), dynamically linked (uses shared libs), for GNU/Linux 2.6.32, stripped] at systime Fri Jul 13 13:01:35 CEST 2018</p>
PowerPC_Linux_32_clang	<p>file fastlisp: ELF 32-bit MSB executable, PowerPC or cisco 4500, version 1 (SYSV), dynamically linked (uses shared libs), for GNU/Linux 2.6.32, stripped</p> <p>Compiled on: Linux IBMpower 3.16.0-4-powerpc64 #1 SMP Debian 3.16.43-2+deb8u5 (2017-09-19) ppc64</p> <p>Compiled by: Debian clang version 3.5.0-10 (tags/RELEASE 350/final) (based on LLVM 3.5.0) as [ELF 32-bit MSB executable, PowerPC or cisco 4500, version 1 (SYSV), dynamically linked (uses shared libs), for GNU/Linux 2.6.32, stripped] at systime Fri Jul 13 13:13:35 CEST 2018</p>
PowerPC_Linux_64	<p>file fastlisp: ELF 64-bit MSB executable, 64-bit PowerPC or cisco 7500, version 1 (SYSV), dynamically linked (uses shared libs), for GNU/Linux 2.6.32, stripped</p> <p>Compiled on: Linux IBMpower 3.16.0-4-powerpc64 #1 SMP Debian 3.16.43-2+deb8u5 (2017-09-19) ppc64</p> <p>Compiled by: gcc version 4.9.2 (Debian 4.9.2-10) as [ELF 64-bit MSB executable, 64-bit PowerPC or cisco 7500, version 1 (SYSV), dynamically linked (uses shared libs), for GNU/Linux 2.6.32, stripped] at systime Fri Jul 13 13:03:38 CEST 2018</p>
PowerPC_Linux_64_clang	<p>file fastlisp: ELF 64-bit MSB executable, 64-bit PowerPC or cisco 7500, version 1 (SYSV), dynamically linked (uses shared libs), for GNU/Linux 2.6.32, stripped</p> <p>Compiled on: Linux IBMpower 3.16.0-4-powerpc64 #1 SMP Debian 3.16.43-2+deb8u5 (2017-09-19) ppc64</p> <p>Compiled by: Debian clang version 3.5.0-10 (tags/RELEASE 350/final) (based on LLVM 3.5.0) as [ELF 64-bit MSB executable, 64-bit PowerPC or cisco 7500, version 1 (SYSV), dynamically linked (uses shared libs), for GNU/Linux 2.6.32, stripped] at systime Fri Jul 13 13:14:46 CEST 2018</p>

Appendix C

PowerPC_FreeBSD_32	<p>file fastlisp: ELF 32-bit MSB executable, PowerPC or cisco 4500, version 1 (FreeBSD), dynamically linked (uses shared libs), for FreeBSD 9.3, stripped</p> <p>Compiled on: FreeBSD PowerBSD 9.3-RELEASE FreeBSD 9.3-RELEASE #0 r268512: Fri Jul 11 10:40:38 UTC 2014 root@snap.freebsd.org:/usr/obj/powerpc.powerpc64/usr/src/sys/GENERIC64 powerpc</p> <p>Compiled by: gcc version 4.2.1 20070831 patched [FreeBSD] (Configured with: FreeBSD/powerpc64 system compiler) as [ELF 32-bit MSB executable, PowerPC or cisco 4500, version 1 (FreeBSD), dynamically linked (uses shared libs), for FreeBSD 9.3, stripped] at systime Fri Jul 13 13:01:36 CEST 2018</p>
PowerPC_FreeBSD_32_clang	<p>file fastlisp: ELF 32-bit MSB executable, PowerPC or cisco 4500, version 1 (FreeBSD), dynamically linked (uses shared libs), for FreeBSD 9.3, stripped</p> <p>Compiled on: FreeBSD PowerBSD 9.3-RELEASE FreeBSD 9.3-RELEASE #0 r268512: Fri Jul 11 10:40:38 UTC 2014 root@snap.freebsd.org:/usr/obj/powerpc.powerpc64/usr/src/sys/GENERIC64 powerpc</p> <p>Compiled by: FreeBSD clang version 3.4.1 (tags/RELEASE 34/dot1-final 208032) 20140512 as [ELF 32-bit MSB executable, PowerPC or cisco 4500, version 1 (FreeBSD), dynamically linked (uses shared libs), for FreeBSD 9.3, stripped] at systime Fri Jul 13 13:21:49 CEST 2018</p>
PowerPC_FreeBSD_64	<p>file fastlisp: ELF 64-bit MSB executable, 64-bit PowerPC or cisco 7500, version 1 (FreeBSD), dynamically linked (uses shared libs), for FreeBSD 9.3, stripped</p> <p>Compiled on: FreeBSD PowerBSD 9.3-RELEASE FreeBSD 9.3-RELEASE #0 r268512: Fri Jul 11 10:40:38 UTC 2014 root@snap.freebsd.org:/usr/obj/powerpc.powerpc64/usr/src/sys/GENERIC64 powerpc</p> <p>Compiled by: gcc version 4.2.1 20070831 patched [FreeBSD] (Configured with: FreeBSD/powerpc64 system compiler) as [ELF 64-bit MSB executable, 64-bit PowerPC or cisco 7500, version 1 (FreeBSD), dynamically linked (uses shared libs), for FreeBSD 9.3, stripped] at systime Fri Jul 13 13:05:02 CEST 2018</p>
PowerPC_FreeBSD_64_clang	<p>file fastlisp: ELF 64-bit MSB executable, 64-bit PowerPC or cisco 7500, version 1 (FreeBSD), dynamically linked (uses shared libs), for FreeBSD 9.3, stripped</p> <p>Compiled on: FreeBSD PowerBSD 9.3-RELEASE FreeBSD 9.3-RELEASE #0 r268512: Fri Jul 11 10:40:38 UTC 2014 root@snap.freebsd.org:/usr/obj/powerpc.powerpc64/usr/src/sys/GENERIC64 powerpc</p> <p>Compiled by: FreeBSD clang version 3.4.1 (tags/RELEASE 34/dot1-final 208032) 20140512 as [ELF 64-bit MSB executable, 64-bit PowerPC or cisco 7500, version 1 (FreeBSD), dynamically linked (uses shared libs), for FreeBSD 9.3, stripped] at systime Fri Jul 13 13:24:33 CEST 2018</p>

PowerPCle_Linux_32	<p>file fastlisp: ELF 32-bit LSB executable, PowerPC or cisco 4500, version 1 (SYSV), dynamically linked (uses shared libs), for GNU/Linux 2.6.32, stripped</p> <p>Compiled on: Linux RedHatELS62VM 2.6.32-220.13.1.el6.x86_64 #1 SMP Thu Mar 29 11:46:40 EDT 2012 x86_64</p> <p>Compiled by: gcc version 5.3.0 (GCC) (cross-toolchain) as [ELF 32-bit LSB executable, PowerPC or cisco 4500, version 1 (SYSV), dynamically linked (uses shared libs), for GNU/Linux 2.6.32, stripped] at systime Fri Jul 13 13:01:15 CEST 2018</p>
PowerPCle_Linux_64	<p>file fastlisp: ELF 64-bit LSB executable, 64-bit PowerPC or cisco 7500, version 1 (SYSV), dynamically linked (uses shared libs), for GNU/Linux 2.6.32, stripped</p> <p>Compiled on: Linux RedHatELS62VM 2.6.32-220.13.1.el6.x86_64 #1 SMP Thu Mar 29 11:46:40 EDT 2012 x86_64</p> <p>Compiled by: gcc version 5.3.0 (GCC) (cross-toolchain) as [ELF 64-bit LSB executable, 64-bit PowerPC or cisco 7500, version 1 (SYSV), dynamically linked (uses shared libs), for GNU/Linux 2.6.32, stripped] at systime Fri Jul 13 13:02:33 CEST 2018</p>
PowerPCle_Linux_64_clang	<p>file fastlisp: ELF 64-bit LSB executable, 64-bit PowerPC or cisco 7500, version 1 (SYSV), dynamically linked (uses shared libs), for GNU/Linux 3.2.0, stripped</p> <p>Compiled on: Linux debian-QEMU 4.9.0-3-powerpc64le #1 SMP Debian 4.9.30-2+deb9u1 (2017-06-18) ppc64le</p> <p>Compiled by: clang version 3.8.1-24 (tags/RELEASE_381/final) as [ELF 64-bit LSB executable, 64-bit PowerPC or cisco 7500, version 1 (SYSV), dynamically linked (uses shared libs), for GNU/Linux 3.2.0, stripped] at systime Fri Jul 13 13:13:35 CEST 2018</p>
PowerPCle_Linux_64_xlC	<p>file fastlisp: ELF 64-bit LSB executable, 64-bit PowerPC or cisco 7500, version 1 (SYSV), dynamically linked (uses shared libs), for GNU/Linux 3.2.0, stripped</p> <p>Compiled on: Linux debian-QEMU 4.9.0-3-powerpc64le #1 SMP Debian 4.9.30-2+deb9u1 (2017-06-18) ppc64le</p> <p>Compiled by: IBM XL C/C++ for Linux, V13.1.6 (Community Edition) Version: 13.01.0006.0001 as [ELF 64-bit LSB executable, 64-bit PowerPC or cisco 7500, version 1 (SYSV), dynamically linked (uses shared libs), for GNU/Linux 3.2.0, stripped] at systime Fri Jul 13 13:24:27 CEST 2018</p>
S390_Linux_32	<p>file fastlisp: ELF 32-bit MSB executable, IBM S/390, version 1 (SYSV), dynamically linked (uses shared libs), for GNU/Linux 2.6.32, stripped</p> <p>Compiled on: Linux RedHatELS62VM 2.6.32-220.13.1.el6.x86_64 #1 SMP Thu Mar 29 11:46:40 EDT 2012 x86_64</p> <p>Compiled by: gcc version 5.3.0 (GCC) (cross-toolchain) as [ELF 32-bit MSB executable, IBM S/390, version 1 (SYSV), dynamically linked (uses shared libs), for GNU/Linux 2.6.32, stripped] at systime Fri Jul 13 13:01:13 CEST 2018</p>

Appendix C

S390_Linux_64	<p>file fastlisp: ELF 64-bit MSB executable, IBM S/390, version 1 (SYSV), dynamically linked (uses shared libs), for GNU/Linux 2.6.32, stripped</p> <p>Compiled on: Linux RedHatELS62VM 2.6.32-220.13.1.el6.x86_64 #1 SMP Thu Mar 29 11:46:40 EDT 2012 x86_64</p> <p>Compiled by: gcc version 5.3.0 (GCC) (cross-toolchain) as [ELF 64-bit MSB executable, IBM S/390, version 1 (SYSV), dynamically linked (uses shared libs), for GNU/Linux 2.6.32, stripped] at systime Fri Jul 13 13:02:26 CEST 2018</p>
S390_Linux_64_clang	<p>file fastlisp: ELF 64-bit MSB executable, IBM S/390, version 1 (SYSV), dynamically linked (uses shared libs), for GNU/Linux 3.2.0, stripped</p> <p>Compiled on: Linux debian-QEMU 4.9.0-3-s390x #1 SMP Debian 4.9.30-2+deb9u1 (2017-06-18) s390x</p> <p>Compiled by: clang version 3.8.1-24 (tags/RELEASE_381/final) as [ELF 64-bit MSB executable, IBM S/390, version 1 (SYSV), dynamically linked (uses shared libs), for GNU/Linux 3.2.0, stripped] at systime Fri Jul 13 13:10:35 CEST 2018</p>
M68000_Linux_32	<p>file fastlisp: ELF 32-bit MSB executable, Motorola m68k, 68020, version 1 (SYSV), dynamically linked (uses shared libs), for GNU/Linux 2.6.32, stripped</p> <p>Compiled on: Linux RedHatELS62VM 2.6.32-220.13.1.el6.x86_64 #1 SMP Thu Mar 29 11:46:40 EDT 2012 x86_64</p> <p>Compiled by: gcc version 5.3.0 (GCC) (cross-toolchain) as [ELF 32-bit MSB executable, Motorola m68k, 68020, version 1 (SYSV), dynamically linked (uses shared libs), for GNU/Linux 2.6.32, stripped] at systime Fri Jul 13 13:01:13 CEST 2018</p>
ARM_Linux_32	<p>file fastlisp: ELF 32-bit LSB executable, ARM, version 1, dynamically linked (uses shared libs), for GNU/Linux 2.6.0, stripped</p> <p>Compiled on: Linux RedHatELS62VM 2.6.32-220.13.1.el6.x86_64 #1 SMP Thu Mar 29 11:46:40 EDT 2012 x86_64</p> <p>Compiled by: gcc version 4.1.1 (GCC) (cross-toolchain) as [ELF 32-bit LSB executable, ARM, version 1, dynamically linked (uses shared libs), for GNU/Linux 2.6.0, stripped] at systime Fri Jul 13 13:01:13 CEST 2018</p>
ARM_Linux_32_eabi	<p>file fastlisp: ELF 32-bit LSB executable, ARM, EABI5 version 1 (SYSV), dynamically linked (uses shared libs), for GNU/Linux 3.2.0, stripped</p> <p>Compiled on: Linux DebianLinux 4.9.0-3-amd64 #1 SMP Debian 4.9.30-2+deb9u5 (2017-09-19) x86_64</p> <p>Compiled by: gcc version 6.3.0 20170516 (Debian 6.3.0-18) (cross-toolchain) as [ELF 32-bit LSB executable, ARM, EABI5 version 1 (SYSV), dynamically linked (uses shared libs), for GNU/Linux 3.2.0, stripped] at systime Fri Jul 13 13:01:29 CEST 2018</p>

ARM_Linux_32_eabihf	<p>file fastlisp: ELF 32-bit LSB executable, ARM, EABI5 version 1 (SYSV), dynamically linked (uses shared libs), for GNU/Linux 3.2.0, stripped</p> <p>Compiled on: Linux DebianLinux 4.9.0-3-amd64 #1 SMP Debian 4.9.30-2+deb9u5 (2017-09-19) x86_64</p> <p>Compiled by: gcc version 6.3.0 20170516 (Debian 6.3.0-18) (cross-toolchain) as [ELF 32-bit LSB executable, ARM, EABI5 version 1 (SYSV), dynamically linked (uses shared libs), for GNU/Linux 3.2.0, stripped] at systime Fri Jul 13 13:01:27 CEST 2018</p>
ARM_Linux_32_eabihfclang	<p>file fastlisp: ELF 32-bit LSB executable, ARM, EABI5 version 1 (SYSV), dynamically linked (uses shared libs), for GNU/Linux 3.2.0, stripped</p> <p>Compiled on: Linux debian-QEMU 4.9.0-3-armmp-lpae #1 SMP Debian 4.9.30-2+deb9u1 (2017-06-18) armv7l</p> <p>Compiled by: clang version 3.8.1-24 (tags/RELEASE_381/final) as [ELF 32-bit LSB executable, ARM, EABI5 version 1 (SYSV), dynamically linked (uses shared libs), for GNU/Linux 3.2.0, stripped] at systime Fri Jul 13 13:06:27 CEST 2018</p>
ARM_Linux_64	<p>file fastlisp: ELF 64-bit LSB executable, ARM aarch64, version 1 (SYSV), dynamically linked (uses shared libs), for GNU/Linux 3.7.0, stripped</p> <p>Compiled on: Linux RedHatELS62VM 2.6.32-220.13.1.el6.x86_64 #1 SMP Thu Mar 29 11:46:40 EDT 2012 x86_64</p> <p>Compiled by: gcc version 5.3.0 (GCC) (cross-toolchain) as [ELF 64-bit LSB executable, ARM aarch64, version 1 (SYSV), dynamically linked (uses shared libs), for GNU/Linux 3.7.0, stripped] at systime Fri Jul 13 13:02:04 CEST 2018</p>
ARM_Linux_64_clang	<p>file fastlisp: ELF 64-bit LSB executable, ARM aarch64, version 1 (SYSV), dynamically linked (uses shared libs), for GNU/Linux 3.7.0, stripped</p> <p>Compiled on: Linux debian-QEMU 4.9.0-3-arm64 #1 SMP Debian 4.9.30-2 (2017-06-12) aarch64</p> <p>Compiled by: clang version 3.8.1-24 (tags/RELEASE_381/final) as [ELF 64-bit LSB executable, ARM aarch64, version 1 (SYSV), dynamically linked (uses shared libs), for GNU/Linux 3.7.0, stripped] at systime Fri Jul 13 13:07:43 CEST 2018</p>
ARM_Android_32	<p>file fastlisp: ELF 32-bit LSB executable, ARM, EABI5 version 1 (SYSV), dynamically linked (uses shared libs), stripped</p> <p>Compiled on: Linux DebianLinux 4.9.0-3-amd64 #1 SMP Debian 4.9.30-2+deb9u5 (2017-09-19) x86_64</p> <p>Compiled by: gcc version 4.9.x 20150123 (pre-release) (GCC) (cross-toolchain) (arm arm-linux-androideabi -D ANDROID_API=26) as [ELF 32-bit LSB executable, ARM, EABI5 version 1 (SYSV), dynamically linked (uses shared libs), stripped] at systime Fri Jul 13 13:01:32 CEST 2018</p>
ARM_Android_32_clang	<p>file fastlisp: ELF 32-bit LSB executable, ARM, EABI5 version 1 (SYSV), dynamically linked (uses shared libs), stripped</p> <p>Compiled on: Linux DebianLinux 4.9.0-3-amd64 #1 SMP Debian 4.9.30-2+deb9u5 (2017-09-19) x86_64</p> <p>Compiled by: clang version 5.0.300080 (based on LLVM 5.0.300080) (cross-toolchain) (arm arm-linux-androideabi -D ANDROID_API=26) as [ELF 32-bit LSB executable, ARM, EABI5 version 1 (SYSV), dynamically linked (uses shared libs), stripped] at systime Fri Jul 13 13:10:46 CEST 2018</p>

Appendix C

ARM_Android_64	<p>file fastlisp: ELF 64-bit LSB executable, ARM aarch64, version 1 (SYSV), dynamically linked (uses shared libs), stripped</p> <p>Compiled on: Linux DebianLinux 4.9.0-3-amd64 #1 SMP Debian 4.9.30-2+deb9u5 (2017-09-19) x86_64</p> <p>Compiled by: gcc version 4.9.x 20150123 (prerelease) (GCC) (cross-toolchain) (arm64 aarch64-linux-android -D_ANDROID_API_=26) as [ELF 64-bit LSB executable, ARM aarch64, version 1 (SYSV), dynamically linked (uses shared libs), stripped] at systime Fri Jul 13 13:03:08 CEST 2018</p>
ARM_Android_64_clang	<p>file fastlisp: ELF 64-bit LSB executable, ARM aarch64, version 1 (SYSV), dynamically linked (uses shared libs), stripped</p> <p>Compiled on: Linux DebianLinux 4.9.0-3-amd64 #1 SMP Debian 4.9.30-2+deb9u5 (2017-09-19) x86_64</p> <p>Compiled by: clang version 5.0.300080 (based on LLVM 5.0.300080) (cross-toolchain) (arm64 aarch64-linux-android -D_ANDROID_API_=26) as [ELF 64-bit LSB executable, ARM aarch64, version 1 (SYSV), dynamically linked (uses shared libs), stripped] at systime Fri Jul 13 13:12:03 CEST 2018</p>
ARMbe_Linux_64	<p>file fastlisp: ELF 64-bit MSB executable, ARM aarch64, version 1 (SYSV), dynamically linked (uses shared libs), for GNU/Linux 3.7.0, stripped</p> <p>Compiled on: Linux RedHatELS62VM 2.6.32-220.13.1.el6.x86_64 #1 SMP Thu Mar 29 11:46:40 EDT 2012 x86_64</p> <p>Compiled by: gcc version 5.3.0 (GCC) (cross-toolchain) as [ELF 64-bit MSB executable, ARM aarch64, version 1 (SYSV), dynamically linked (uses shared libs), for GNU/Linux 3.7.0, stripped] at systime Fri Jul 13 13:01:20 CEST 2018</p>
RISCV_Linux_64	<p>file fastlisp: ELF 64-bit LSB executable, UCB RISC-V, version 1 (SYSV), dynamically linked (uses shared libs), for GNU/Linux 4.15.0, stripped</p> <p>Compiled on: Linux RedHatELS72VM 3.10.0-514.26.2.el7.x86_64 #1 SMP Fri Jun 30 05:26:04 UTC 2017 x86_64</p> <p>Compiled by: gcc version 7.3.0 (GCC) (cross-toolchain) as [ELF 64-bit LSB executable, UCB RISC-V, version 1 (SYSV), dynamically linked (uses shared libs), for GNU/Linux 4.15.0, stripped] at systime Fri Jul 13 13:01:14 CEST 2018</p>

This page is intentionally left blank.
This is the last page of the document.